

ISSN 0007-2621

No. 3 - 1979

published quarterly

Technical Review

To Advance Techniques in Acoustical, Electrical and Mechanical Measurement

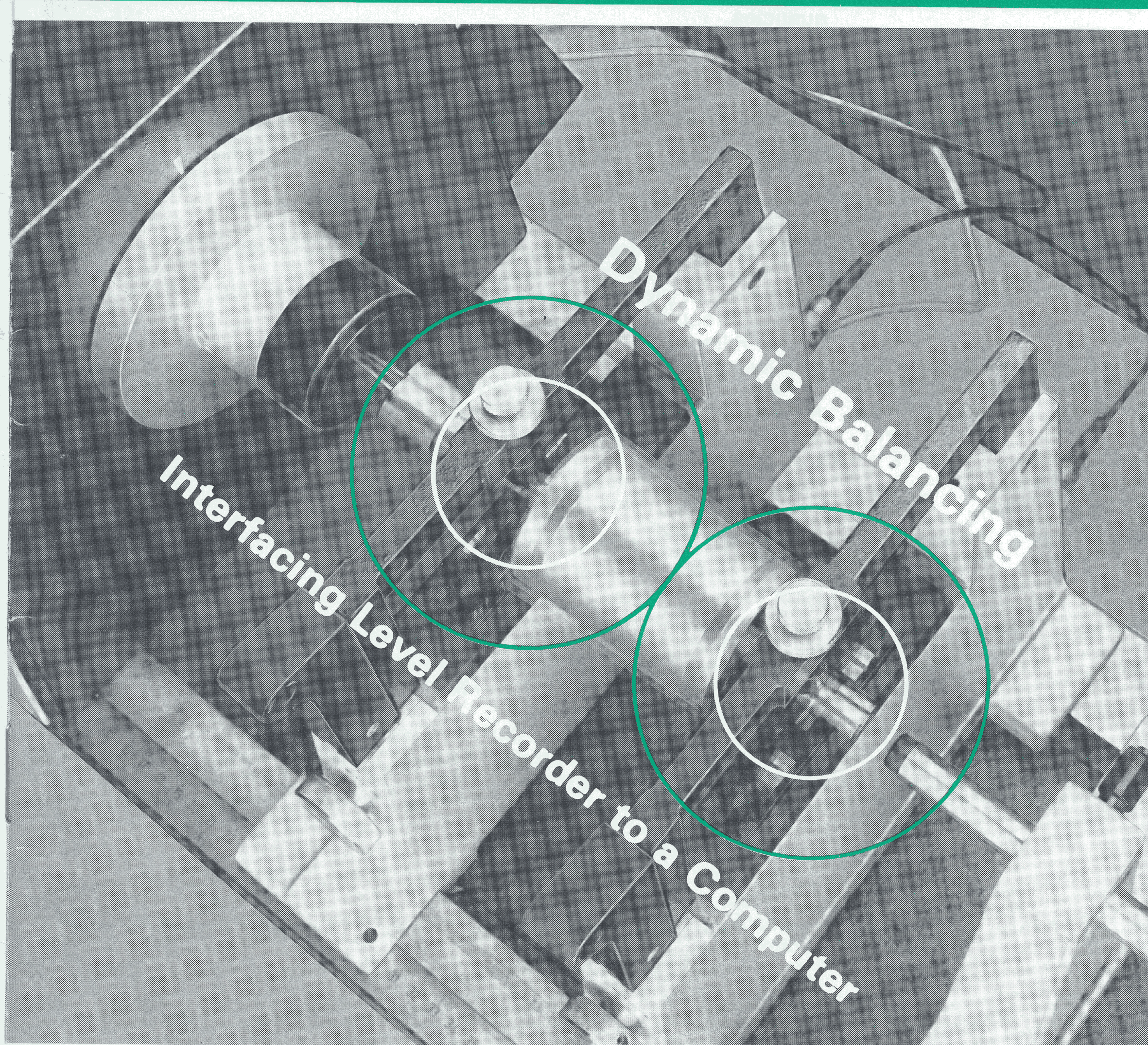

Interfacing Level Recorder to a Computer

Dynamic Balancing



Brüel & Kjær

**PREVIOUSLY ISSUED NUMBERS OF
BRÜEL & KJÆR TECHNICAL REVIEW**

- 2-1979 Acoustic Emission
1-1979 The Discrete Fourier Transform and FFT Analyzers.
4-1978 Reverberation Process at Low Frequencies.
3-1978 The Enigma of Sound Power Measurements at Low Frequencies.
2-1978 The Application of the Narrow Band Spectrum Analyzer Type 2031 to the Analysis of Transient and Cyclic Phenomena.
Measurement of Effective Bandwidth of Filters.
1-1978 Digital Filters and FFT Technique in Real-time Analysis.
4-1977 General Accuracy of Sound Level Meter Measurements.
Low Impedance Microphone Calibrator and its Advantages.
3-1977 Condenser Microphones used as Sound Sources.
2-1977 Automated Measurements of Reverberation Time using the Digital Frequency Analyzer Type 2131.
Measurement of Elastic Modulus and Loss Factor of PVC at High Frequencies.
1-1977 Digital Filters in Acoustic Analysis Systems.
An Objective Comparison of Analog and Digital Methods of Real-Time Frequency Analysis.
4-1976 An Easy and Accurate Method of Sound Power Measurements.
Measurement of Sound Absorption of rooms using a Reference Sound Source.
3-1976 Registration of Voice Quality.
Acoustic Response Measurements and Standards for Motion-Picture Theatres.
2-1976 Free-Field Response of Sound Level Meters.
High Frequency Testing of Gramophone Cartridges using an Accelerometer.
1-1976 Do We Measure Damaging Noise Correctly?
4-1975 On the Measurement of Frequency Response Functions.
3-1975 On the Averaging Time of RMS Measurements (continuation).
2-1975 On the Averaging Time of RMS Measurements
Averaging Time of Level Recorder Type 2306 and "Fast" and "Slow" Response of Level Recorders 2305/06/07.
1-1975 Problems in Telephone Measurements.
Proposals for the Measurement of Loudness Ratings of Operator's Headsets.
Comparison of Results obtained by Subjective Measuring Methods.
Repeatabilities in Electro-Acoustic Measurements on Telephone Capsules.
Stable Subset Measurements with the 73 D.
Vibration Testing of Telephone Equipment.

(Continued on cover page 3)

TECHNICAL REVIEW

No. 3 — 1979

Contents

The Rationale of Dynamic Balancing by Vibration Measurements by J.F.G. Wort	3
Brief Communication Interfacing Level Recorder Type 2306 to a Digital Computer by M.M. Boone	27
News from the Factory	31

The Rationale of Dynamic Balancing by Vibration Measurement

by

J. F. G. Wort, M. Sc.

ABSTRACT

The concept of the "influence coefficient method" has enjoyed increasing exposure in technical literature, as an alternative to the more traditional method of modal balancing, for balancing of flexible rotors. However, the influence coefficient concept can be very useful in consideration of rigid rotor balancing in two planes. This theme is explored using a soft-bearing balancing machine and a portable balancing set as examples.

SOMMAIRE

Le concept de "méthode des coefficients d'influence" jouit dans la littérature technique d'une popularité croissante en tant qu'alternative pour les rotors flexibles à la méthode plus traditionnelle d'équilibrage modal. Le concept de coefficients d'influence peut cependant se montrer également très utile pour l'équilibrage sur deux plans des rotors rigides. Cette méthode est appliquée aux exemples d'une équilibreuse à paliers souples et d'un ensemble d'équilibrage portatif.

ZUSAMMENFASSUNG

Das Konzept der "Einfluß-Koeffizienten-Methode" tritt in der technischen Literatur immer häufiger als Alternative zu der traditionelleren Methode des Modal-Wuchtens für das Auswuchten flexibler Rotoren auf. Das Einfluß-Koeffizienten-Konzept ist jedoch auch für das Zwei-Ebenen-Wuchten starrer Rotoren mit Vorteil einsetzbar. Dieses Thema wurde am Beispiel einer weichgelagerten Auswuchtmaschine und eines tragbaren Auswuchtsatzes untersucht.

Introduction

Recently, much work has been directed towards improving the unbalance quality of machines with rotating elements. Techniques are available for balancing the rotor system on a purpose-built balancing machine, or for direct measurement on site. Many of these techniques are

applied using vibration transducers to obtain an electric signal proportional to the unbalance of the rotor. However, the way in which the vibration signals measured at two support bearings are processed to indicate unbalance corrections to be made on two correction planes varies considerably. These differences can have important consequences in balancing applications.

The following discussion is concerned primarily with dynamic balancing of rigid rotors. This covers rotational speeds up to approximately 50% of the first natural bending mode of the rotor. As such it includes the first rigid body mode (usually called "static" unbalance as it results in a linear translation of the principal inertia axis with respect to the axis of rotation) and the second rigid body mode (usually called "couple" unbalance as it results in a tilting of the principal inertia axis about the centre of mass). See Fig.1. Dynamic unbalance is any composite state of these two modes, and the process of balancing is performed to adjust the mass distribution of the rotor such that the principal inertia axis and the axis of rotation coincide.

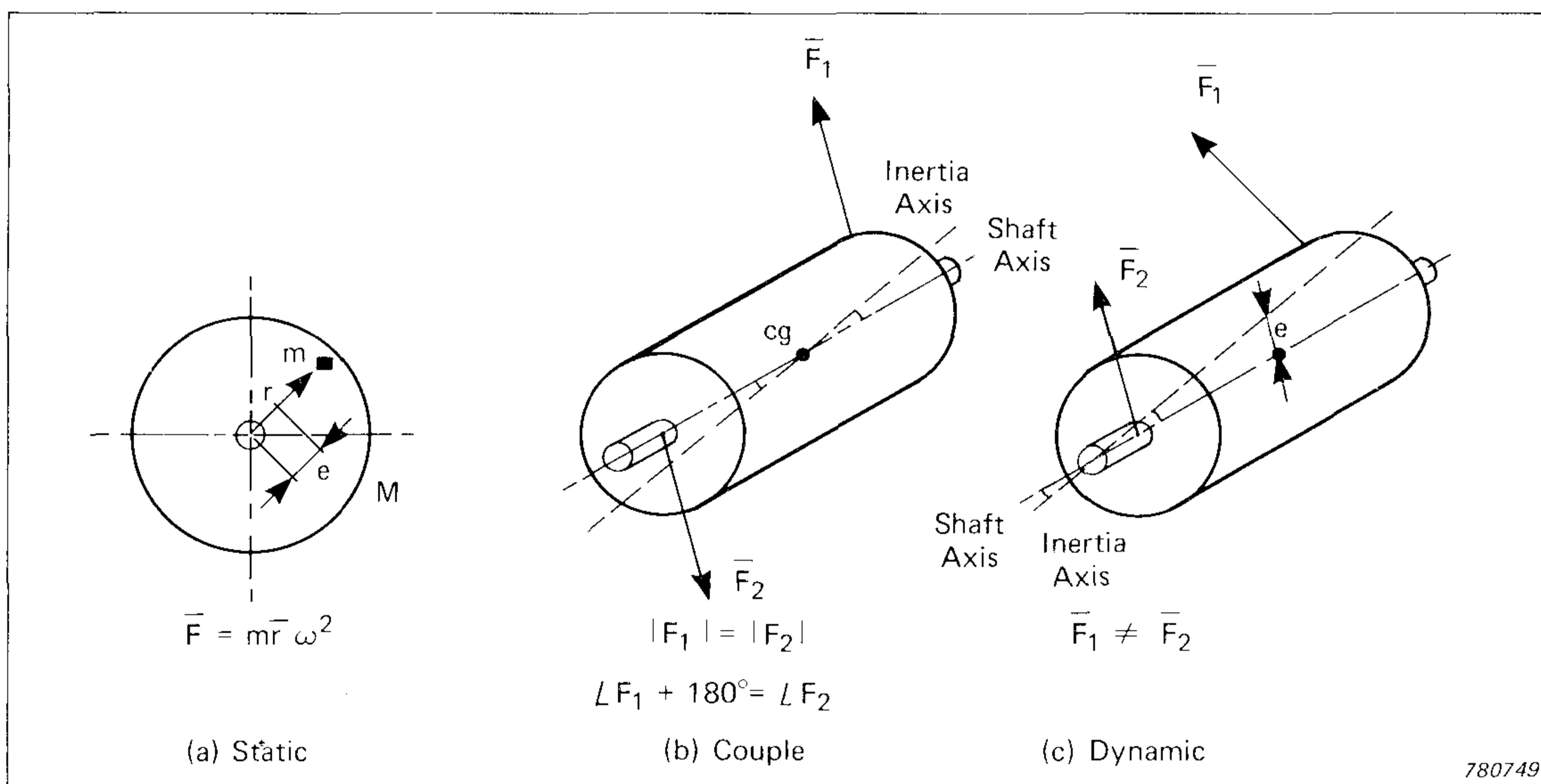

Fig.1. Rigid Rotor Unbalance

Correction of dynamic unbalance will thus require mass redistribution in two planes: these are called correction planes. The general problem may be stated as that of relating the vibrations measured in two planes, usually at the bearings of the rotor, to mass corrections to be made in the two correction planes.

For a given unbalance condition \bar{U}_1 in one correction plane, and \bar{U}_2 in the other, this may be related to vibrations measured at the bearings, \bar{V}_1 and \bar{V}_2 by the relationship:*

$$\bar{V}_1 = \alpha_{11} \bar{U}_1 + \alpha_{12} \bar{U}_2 \quad \bar{V}_2 = \alpha_{21} \bar{U}_1 + \alpha_{22} \bar{U}_2 \quad (1)$$

α_{11} , α_{12} , α_{21} , α_{22} are complex values, usually called influence coefficients. They will be constant at a given speed for a rotor of particular mass and geometry, under particular bearing support conditions. Relationships (1) are conveniently expressed in matrix form as:—

$$\begin{pmatrix} \bar{V}_1 \\ \bar{V}_2 \end{pmatrix} = \begin{bmatrix} \alpha_{11} & \alpha_{12} \\ \alpha_{21} & \alpha_{22} \end{bmatrix} \begin{pmatrix} \bar{U}_1 \\ \bar{U}_2 \end{pmatrix} = \begin{bmatrix} \bar{\alpha} \end{bmatrix} \begin{pmatrix} \bar{U}_1 \\ \bar{U}_2 \end{pmatrix} \quad (2)$$

Knowledge of the influence coefficient matrix $[\bar{\alpha}]$, allows the correction of unbalance in the rotor, according to the relationship: —

$$\begin{pmatrix} \bar{U}_1 \\ \bar{U}_2 \end{pmatrix} = - \begin{bmatrix} \bar{\alpha} \end{bmatrix}^{-1} \begin{pmatrix} \bar{V}_1 \\ \bar{V}_2 \end{pmatrix} \quad (3)$$

Note that the negative sign is introduced to indicate correction values, rather than the actual unbalance value; these values will be equal in magnitude but with 180° phase difference.

For this analysis the principles of superposition and linearity are assumed to hold good. In other words, over the range of interest, any given small change in unbalance state of a rotor will cause the same **change** in resulting vibration, irrespective of the initial unbalance condition.

Throughout this discussion the Brüel & Kjær Type 2504 Balancing Machine Console and Type 9500 Field Balancing Set, are used to illustrate the points made.

The Soft Bearing Balancing Machine

Modern vibration measuring balancing machines operate at rotation speeds appreciably greater than natural frequency of their rotor support

* The convention \bar{U}_1 , \bar{U}_2 etc. is used to indicate that U_1 , U_2 , etc. are vector quantities with both magnitude and direction in some coordinate frame

system. In this condition, the resistance provided by the supports to motion of the rotor in the measuring direction can be neglected — hence the description “soft” — and the rotor is free to rotate about its principal inertia axis. In general, this is different from the geometric axis, due to unbalance and the “soft” support system will oscillate with a deflection corresponding to the eccentricity of the inertia axis at the point of support.

Consider unbalance in a single plane of a uniform homogeneous thin disc of mass M kg. If the unbalance consists of a small mass m g ($m \ll M$) at a radius r mm from the geometric centre causing an unbalance $u = mr$ g-mm an eccentricity e μ m of the centre of mass results when the disc rotates on the soft support.

$$Me \approx mr = u$$

$$\text{or } e = \frac{mr}{M} = \frac{u}{M} \quad (4)$$

Thus e represents the principal axis eccentricity, or the specific unbalance of the disc. It will be the zero-peak value in any measured signal.

By locating a measuring transducer on the geometric axis — at the bearing journal for example — this eccentricity can be measured. It can be seen from Fig.2 that there will always be 180° phase lag between the unbalance and the measured eccentricity.

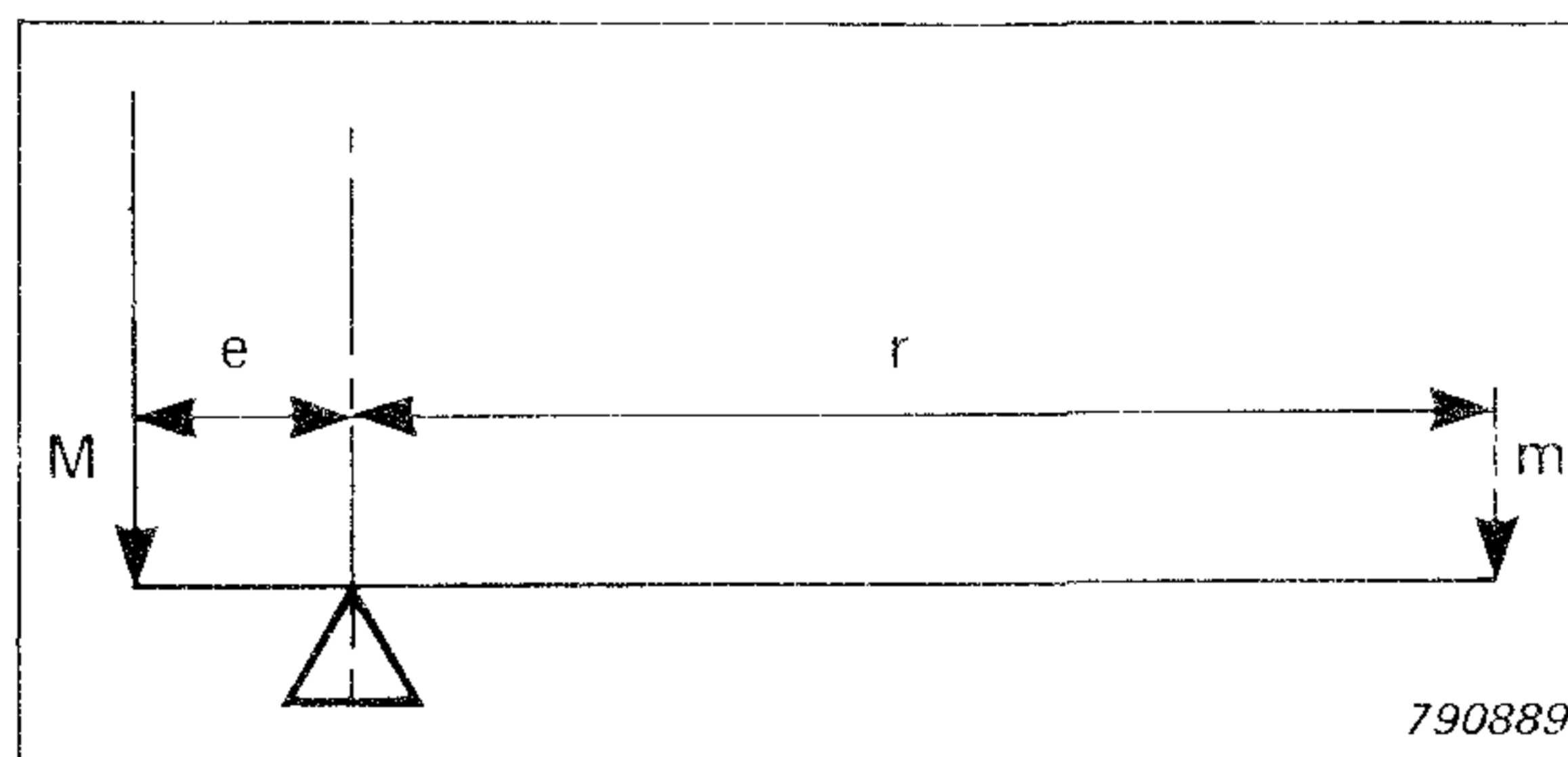

Fig.2. Displacement of Centre of Mass

As an indicator of unbalance quality, displacement or eccentricity is not particularly convenient. It is difficult to apply criteria which may be compared with the subjective behaviour of similar machines which operate at different speeds. Assembled machines may be regarded as composite systems comprising masses, connected by springs and dampers; thus the centre of mass circumferential velocity, the product $e\omega$ where ω is the rotational speed in rads/s (\approx RPM/10), is a much more useful

parameter. This parameter forms the basis for classification of rotors of widely differing types in many of the current standards. It should be noted that for eccentricity e quoted in mm, $e\omega$ is a value in mms^{-1} ; this parameter is quoted in the standards but is given a separate unit (G by ISO, Q by VDI) to avoid confusion: the unbalance is a property of the rotor itself and whilst the value $e\omega$ could be realised on a perfectly soft suspension system, it can never be measured on an assembled machine due to the attenuating effects of ancillary mass, stiffness, and damping.

The measuring system, typically, operates on signals proportional to vibration velocity measured at the support bearings. Velocity sensors or piezo-electric accelerometers, whose output when integrated gives a velocity signal are often used. By obtaining some kind of tachometric pulse, triggered at a known geometric location on the rotor, the phase relationship between the maxima of this velocity signal (now with 90° phase lag with respect to the local inertia axis eccentricity) and the tachometric pulse may be measured. The amplitude of the vibration can be measured directly. There remains, however, the problem of relating amplitude and phase of the measured signals to required unbalance corrections in the selected correction planes, as summarised in Equation (3).

For a dedicated balancing machine, the "influence coefficient matrix" takes the form of hard-wired, electronic processing. Because the characteristics of the supports are designed to be linear, and soft in the sensitive direction, the realisation of the electronic simulation of these matrix terms is considerably simplified.

The physical process of calibrating a Balancing Machine Console, so that indicated values represent calibrated correction values in the selected correction plane is summarised in Fig.3.

The rotor is initially in a state of dynamic unbalance, (a). By introducing electronic "Compensators", anti-phase signals can be generated in the Console allowing the signals measured at A and B to be balanced electronically, (b). A known value of unbalance, whether in g, g-mm, mm bore depth etc., is introduced in one of the available correction planes, (c). All resulting unbalance is now assumed attributable to this unbalance value: the new condition will be indicated predominantly in one measuring channel (the major influence), though there will be cross-influence to the other (the minor influence). The display for the major channel can be adjusted using a gain potentiometer; this may be re-

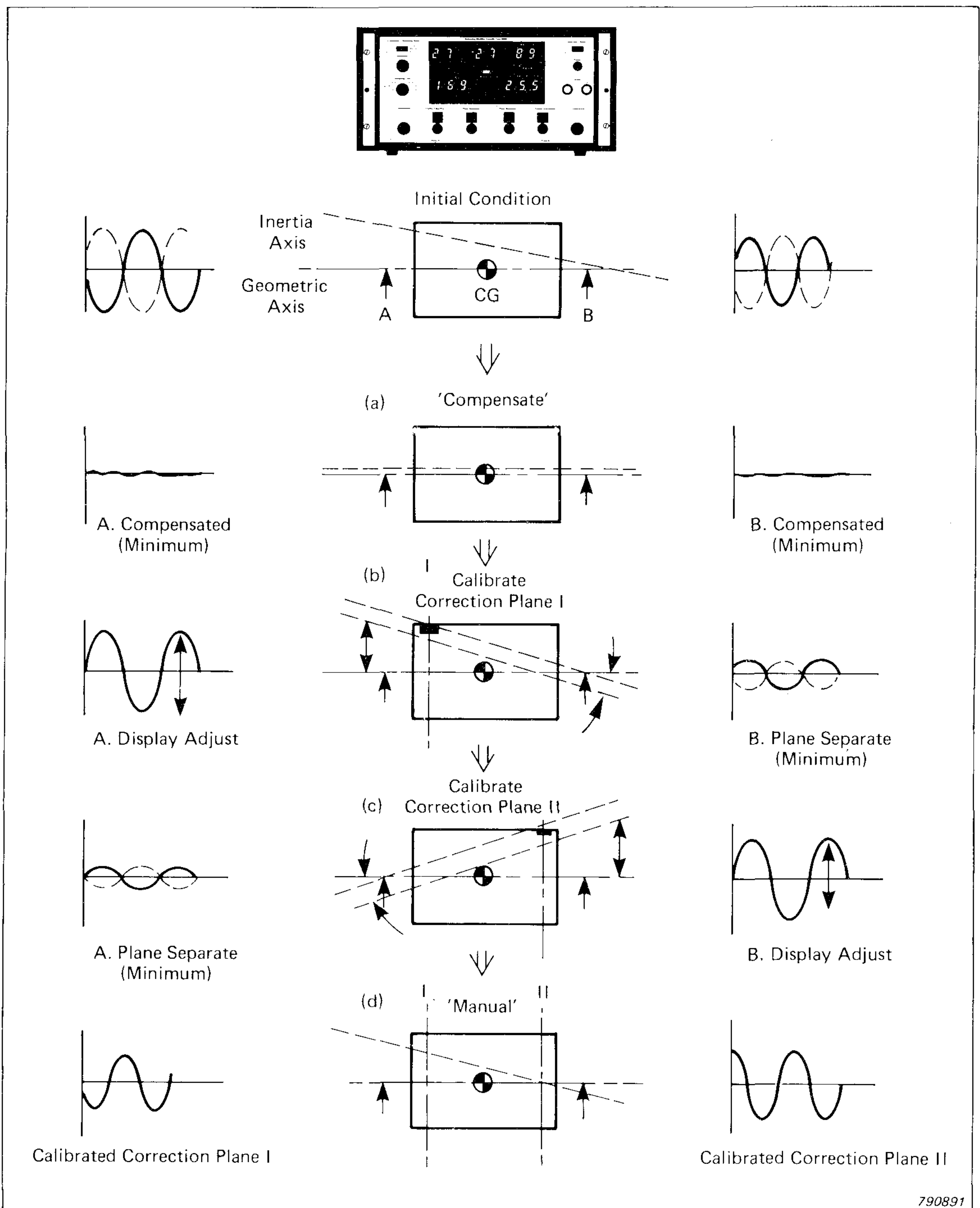

Fig.3. Calibration Procedure

garded as linear translation of the principal inertia axis such that the display magnitude corresponds to the known unbalance value. For the minor channel, cross-influence must be minimised, if vibration measured at the major channel transducer is to be used to generate correction values for the associated correction plane. The cross-influence will

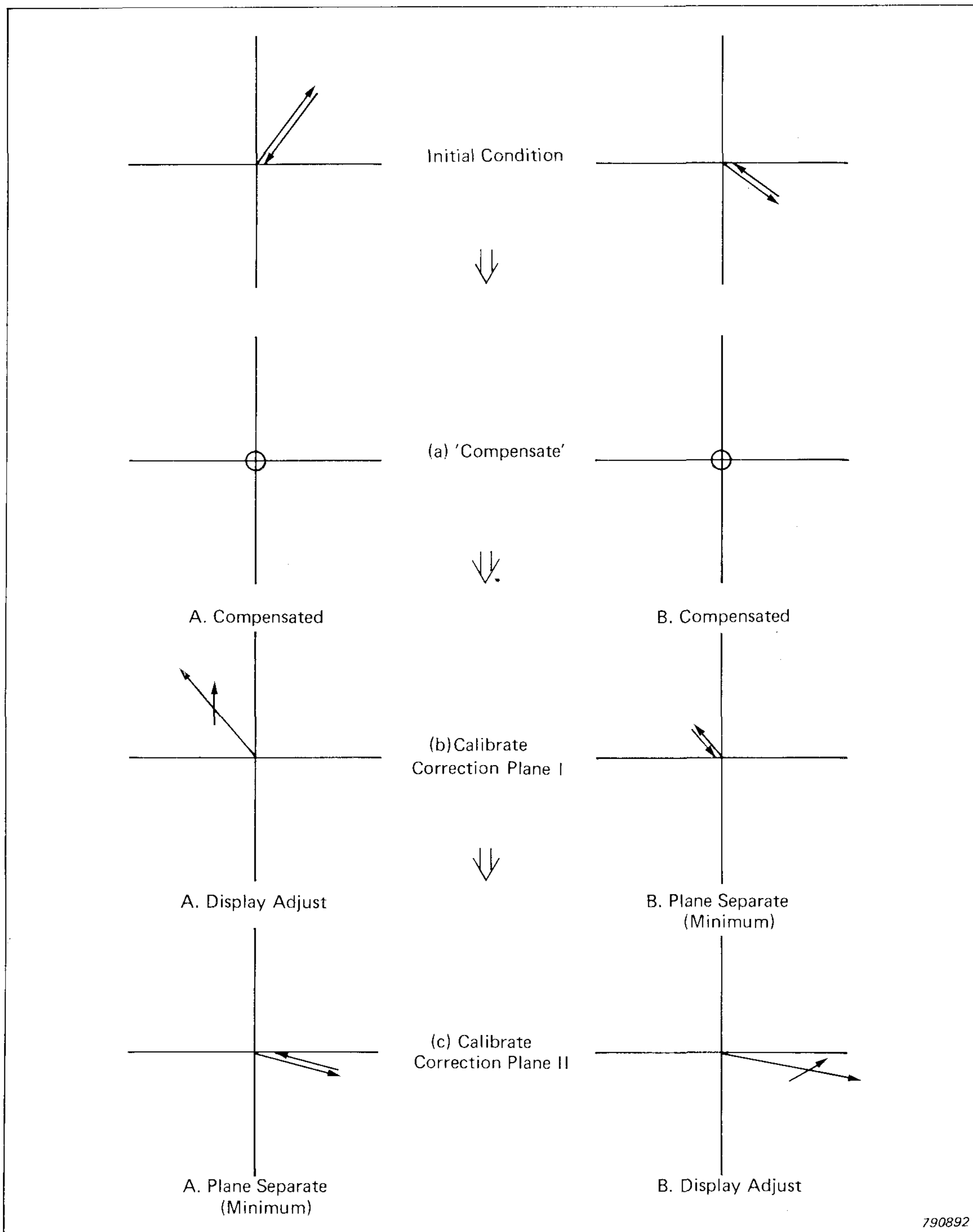

Fig.4. Calibration Procedure — Vector Format

be entirely in-phase, or in anti-phase for two support systems of similar characteristics: thus it is only necessary to mix a portion of the major channel signal, either in phase or anti-phase, with the minor channel signal, to eliminate cross influences on the display. The operation of

the "Plane Separator" control enables the principal inertia axis to be rotated, such that it intersects the geometric axis at B. The amplitude at A is changed.

The operation is repeated for the second correction plane, (d). The display amplitude is adjusted using a gain potentiometer, whilst cross-influences are eliminated by mixing a portion of the associated major signal, with that arising from the other transducer.

The process may also be shown in vector form as in Fig.4 which facilitates comparison with the field balancing approach.

Such a calibration procedure is performed once for a given rotor type. In normal operation with the "Compensators" circuits switched off, and the planes "Separated", the values indicated on each of the two displays represent the necessary corrections in the chosen correction planes.

Referring to the relationships (1), \bar{V}_1 has been electronically processed to a display of \bar{U}_1 , and \bar{V}_2 has been processed to give a display of \bar{U}_2 , whilst cross influences have been eliminated. Rewriting relationship (3):

$$\begin{pmatrix} \bar{V}_1 \\ \bar{V}_2 \end{pmatrix} = - \begin{bmatrix} 1 & 0 \\ 0 & 1 \end{bmatrix} \begin{pmatrix} \bar{U}_1 \\ \bar{U}_2 \end{pmatrix} \quad (5)$$

In effect, the more complex problem of two-plane unbalance has been degenerated by decoupling the two modes to achieve two simpler problems of single-plane unbalance referred to the two correction planes. The Console and all its associated circuitry, serve as a dedicated balancing computer.

The In-Situ Balancing Concept

Field balancing, of necessity, dictates the use of a lightweight compact measuring system, with sufficient versatility to tackle a wide range of tasks.

When measuring a vibration signal on the bearing of an assembled machine, interpretation of amplitude and phase relative to a tachometric reference is made more difficult due to the unknown nature of the bearing supports. It is unlikely to be operating "above resonance", and might in practice be operating anywhere in the region from hard to soft. The

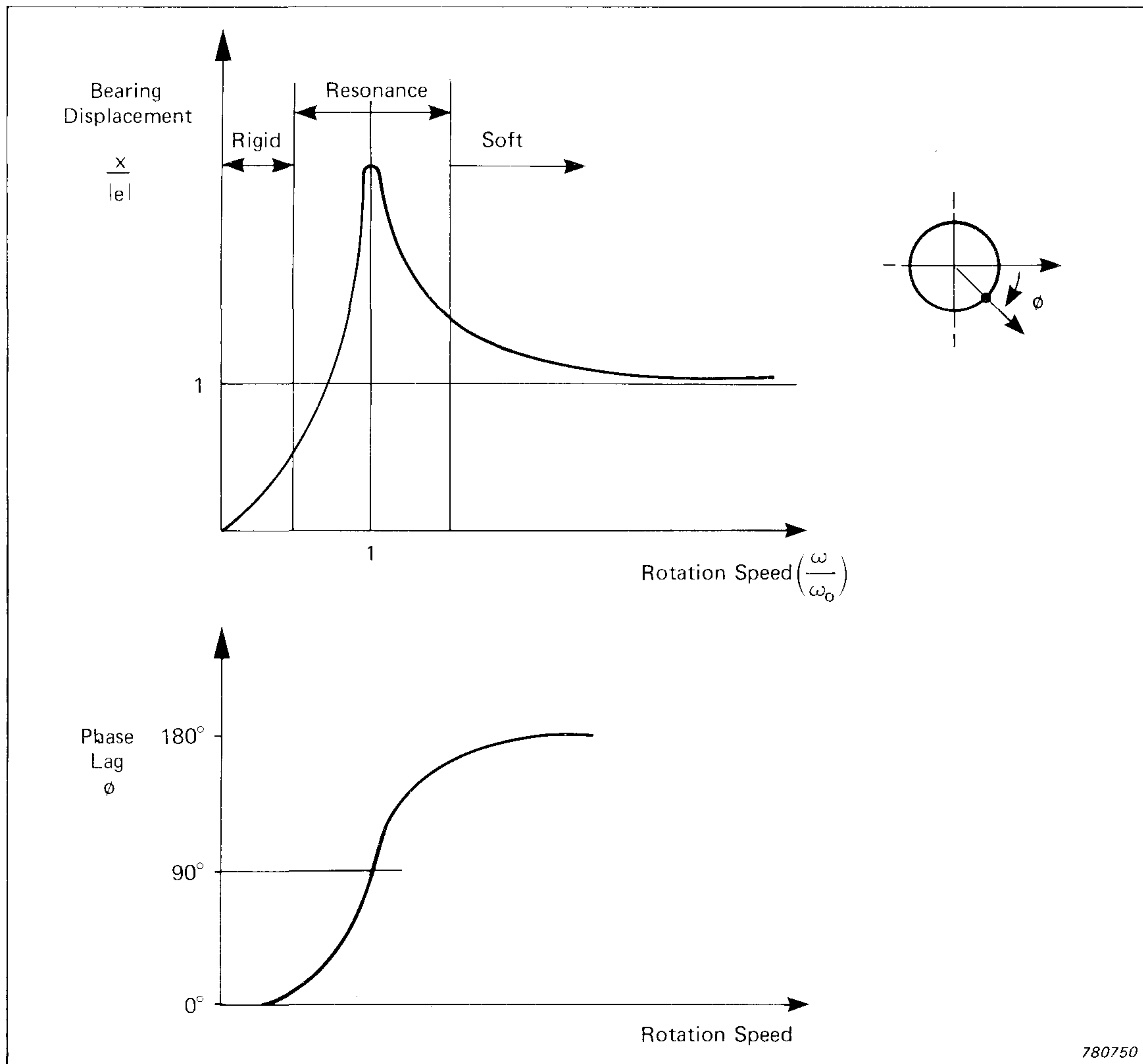

Fig.5. Response of a single degree of freedom support system to unbalance force input

transfer function of the support system, that is the manner in which it modifies the amplitude and phase characteristic of a vibration response signal due to an unbalance force input at any operational speed is unknown. The characteristics of a single degree of freedom support with natural frequency ω_0 are shown in Fig.5.

However, the effects of introducing known unbalance in each of the correction planes, and measuring its consequent effects in the two measuring planes can be carried out in a similar procedure to that described in the section above. In this case the individual vibration vector values are noted at each stage, and the subsequent analysis is performed graphically or by using numerical calculation techniques.

To generate elements α_{11} , α_{21} in the matrix a test unbalance U_{T1} of known value is placed in plane 1. If the vibration measured at bearing 1 has changed from an original value \bar{V}_{10} to a new value \bar{V}_{11} , whilst the vibration at bearing 2 changes from an original value \bar{V}_{20} to a new value \bar{V}_{21} , then the vibration changes attributable to the test unbalance are $(\bar{V}_{11} - \bar{V}_{10})$ and $(\bar{V}_{21} - \bar{V}_{20})$ respectively.

Using the relationships (1):

$$\left(\bar{V}_{11} - \bar{V}_{10}\right) = \alpha_{11} U_{T1} \quad \left(\bar{V}_{21} - \bar{V}_{20}\right) = \alpha_{21} U_{T1} \quad (6a)$$

$$\alpha_{11} = \frac{\left(\bar{V}_{11} - \bar{V}_{10}\right)}{U_{T1}} \quad \alpha_{21} = \frac{\left(\bar{V}_{21} - \bar{V}_{20}\right)}{U_{T1}} \quad (6b)$$

Similarly, α_{12} and α_{22} may be generated using a known unbalance U_{T2} placed in plane 2 causing new vibration values of \bar{V}_{12} and \bar{V}_{22} respectively.

The changes attributable to the test unbalance are $(\bar{V}_{12} - \bar{V}_{10})$ and $(\bar{V}_{22} - \bar{V}_{20})$.

$$\left(\bar{V}_{12} - \bar{V}_{10}\right) = \alpha_{12} U_{T2} \quad \left(\bar{V}_{22} - \bar{V}_{20}\right) = \alpha_{22} U_{T2} \quad (7a)$$

$$\text{Thus: } \alpha_{12} = \frac{\left(\bar{V}_{12} - \bar{V}_{10}\right)}{U_{T2}} \quad \alpha_{22} = \frac{\left(\bar{V}_{22} - \bar{V}_{20}\right)}{U_{T2}} \quad (7b)$$

Knowing these coefficients, the unbalance corrections may be calculated for any two measured vibration vectors. So to correct \bar{V}_{10} and \bar{V}_{20} equation (3) may be written:

$$\begin{pmatrix} \bar{U}_{C1} \\ \bar{U}_{C2} \end{pmatrix} = - \begin{bmatrix} \bar{\alpha} \end{bmatrix}^{-1} \begin{pmatrix} \bar{V}_{10} \\ \bar{V}_{20} \end{pmatrix} \quad (8)$$

where the coefficients in the influence matrix $[\alpha]$ are as found in (6) and (7).

The vector representation of the problem is shown in Fig.6. The generation of $(\bar{V}_{11} - \bar{V}_{10})$ and $(\bar{V}_{21} - \bar{V}_{20})$ is shown in (a), $(\bar{V}_{12} - \bar{V}_{20})$

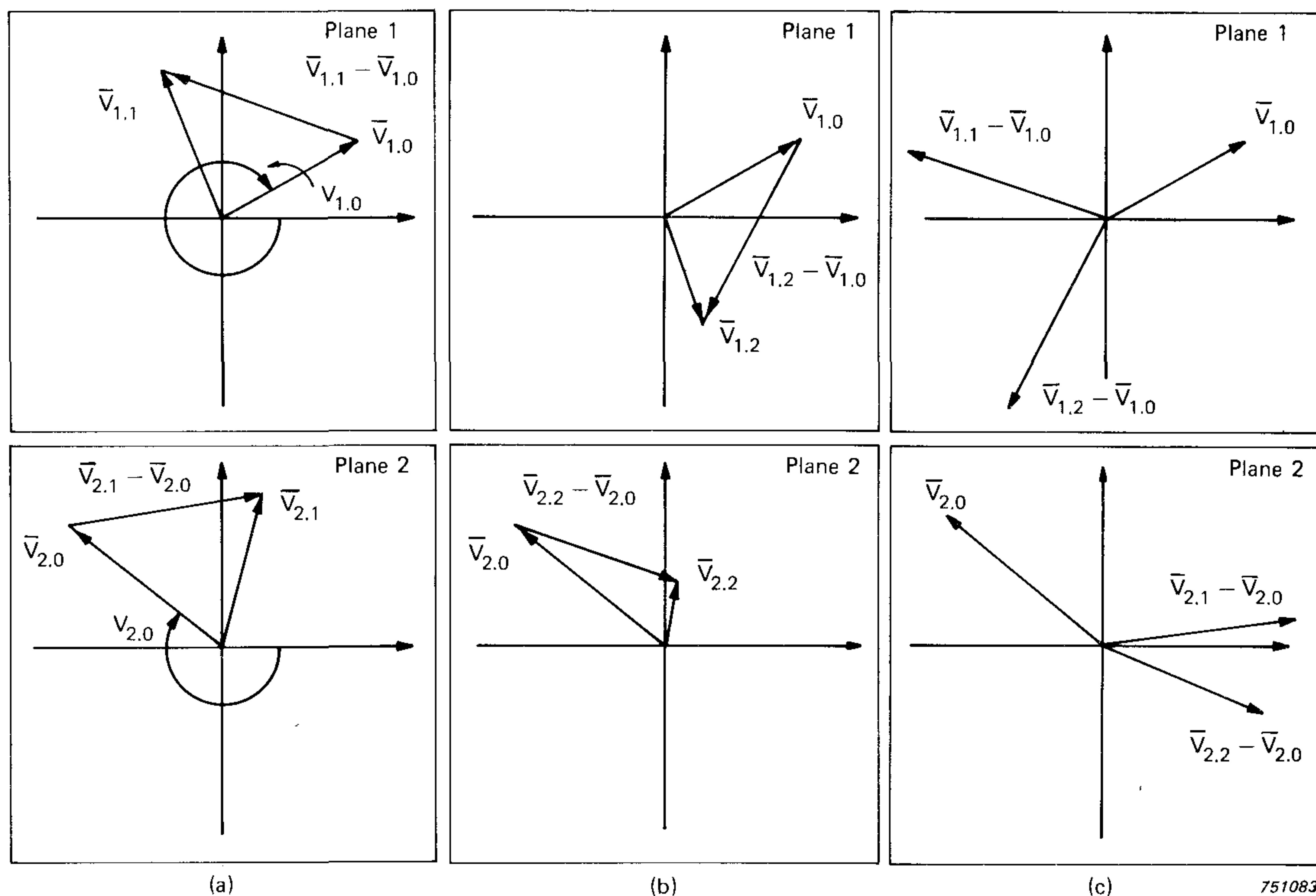

Fig. 6. Vectorial representation of the vibration levels

and $(\bar{V}_{22} - \bar{V}_{20})$ in (b). The problem of relating these measured influences to correct initial measured values of \bar{V}_{10} and \bar{V}_{20} is summarised in (c).

This problem can be solved graphically, but this is both time consuming and necessitates the use of a linear ruler and practical commercial paper sizes. Modern numerical techniques using small computers, or even programmable pocket calculators, gives a speed and numerical calculating power to enable precision results to be achieved quickly. Such a program written in BASIC is shown in Fig. 7: Texas Instruments and Hewlett Packard calculators are also in common use.

Comments on The Balancing Console

The prime feature of the Console approach is the simplicity it offers the operator, once set up for a given rotor type. Where the support system is designed to be light, maximum sensitivity can be achieved, and vibration values ($e\omega$) very closely approximated.

A measuring capability of $0,1$ to 250 mms^{-1} will usually cover the requirement for most types of rotors to be balanced on this measuring

```

DYNBAL WW 1326
LIST
10 DIM C(2,2),D(2,2),E(2,2),F(2,2),G(2,2),H(2,2),I(2,2),J(2,2)
12 DIM K(2,2),L(2,2),M(2,2),N(2,2),O(2,2),P(2,2),Q(2,2),R(2,2)
14 DIM S(2,2),T(2,2),U(2,2),V(2,2),X(2,2)
20 FOR Y= 1 TO 6
30 READ A(Y),B(Y)
35 LET B(Y)=B(Y)*ATN( 1)/ 45
40 NEXT Y
50 LET C( 1, 1)=A( 1)*COS(B( 1))
60 LET C( 1, 2)=A( 1)*SIN(B( 1))
62 LET C( 2, 1)=-C( 1, 2)
65 LET C( 2, 2)=C( 1, 1)
70 LET D( 1, 1)=A( 2)*COS(B( 2))
75 LET D( 1, 2)=A( 2)*SIN(B( 2))
80 LET D( 2, 1)=-D( 1, 2)
85 LET D( 2, 2)=D( 1, 1)
90 LET E( 1, 1)=A( 3)*COS(B( 3))
95 LET E( 1, 2)=A( 3)*SIN(B( 3))
100 LET E( 2, 1)=-E( 1, 2)
105 LET E( 2, 2)=E( 1, 1)
110 LET F( 1, 1)=A( 4)*COS(B( 4))
115 LET F( 1, 2)=A( 4)*SIN(B( 4))
120 LET F( 2, 1)=-F( 1, 2)
125 LET F( 2, 2)=F( 1, 1)
130 LET G( 1, 1)=A( 5)*COS(B( 5))
135 LET G( 1, 2)=A( 5)*SIN(B( 5))
140 LET G( 2, 1)=-G( 1, 2)
145 LET G( 2, 2)=G( 1, 1)
150 LET H( 1, 1)=A( 6)*COS(B( 6))
155 LET H( 1, 2)=A( 6)*SIN(B( 6))
160 LET H( 2, 1)=-H( 1, 2)
165 LET H( 2, 2)=H( 1, 1)
200 MAT I=E-C
205 MAT J=F-D
210 MAT K=G-C
215 MAT L=F-D
220 MAT M=H-D
225 MAT N=E-C
230 MAT O=D*I
235 MAT P=C*J
240 MAT Q=K*L
245 MAT R=M*N
250 MAT S=O-P
255 MAT T=Q-R
260 MAT U=INV(T)
265 MAT V=S*U
270 MAT I=C*M
275 MAT J=D*K
280 MAT K=I-J
285 MAT X=K*U
290 LET Y1=SQR(V( 1, 1)+ 2+V( 1, 2)+ 2)
300 LET Y2=SQR(X( 1, 1)+ 2+X( 1, 2)+ 2)
310 IF V( 1, 1)< 0 THEN 340
320 LET Y3= 0
330 GOTO 350
340 LET Y3= 180
350 IF X( 2, 2)< 0 THEN 380
360 LET Y4= 0
370 GOTO 390
380 LET Y4= 180
390 LET Y5=Y3+(ATN(V( 1, 2)/V( 1, 1)))/ATN( 1)* 45
400 LET Y6=Y4+(ATN(X( 1, 2)/X( 1, 1)))/ATN( 1)* 45
410 PRINT "MØDULUS AND ARGUMENT ØF Q1:",Y2,Y6
420 PRINT "MØDULUS AND ARGUMENT ØF Q2:",Y1,Y5
499 DATA 170, 112, 53, 78, 235, 94, 58, 68, 185, 115, 77, 104
510 END
RUN
MØDULUS AND ARGUMENT ØF Q1:      1.72127      236.17
MØDULUS AND ARGUMENT ØF Q2:      .930879      121.844
READY

```

Fig.7. Dynamic balancing program in BASIC

system by direct comparison with quality grades quoted in ISO—1940 and VDI—2060. As the mass of the rotor is reduced such that the rotor mass is comparable with the overall sprung mass, the amplitude $|x/e|$ for the single degree of freedom system in Fig.5 will be attenuated according to:

$$\left| \frac{x}{e} \right| = \frac{1}{\left(\frac{M_T}{M} \right) + 1}$$

where M = rotor mass

M_T = total sprung mass

This attenuation function may be shown graphically in Fig.8. Thus as rotor mass is reduced, the measured displacement no longer corresponds exactly to the inertia axis eccentricity, but this does not affect the ability to balance of course, when modern measuring transducers of appropriate sensitivity are used.

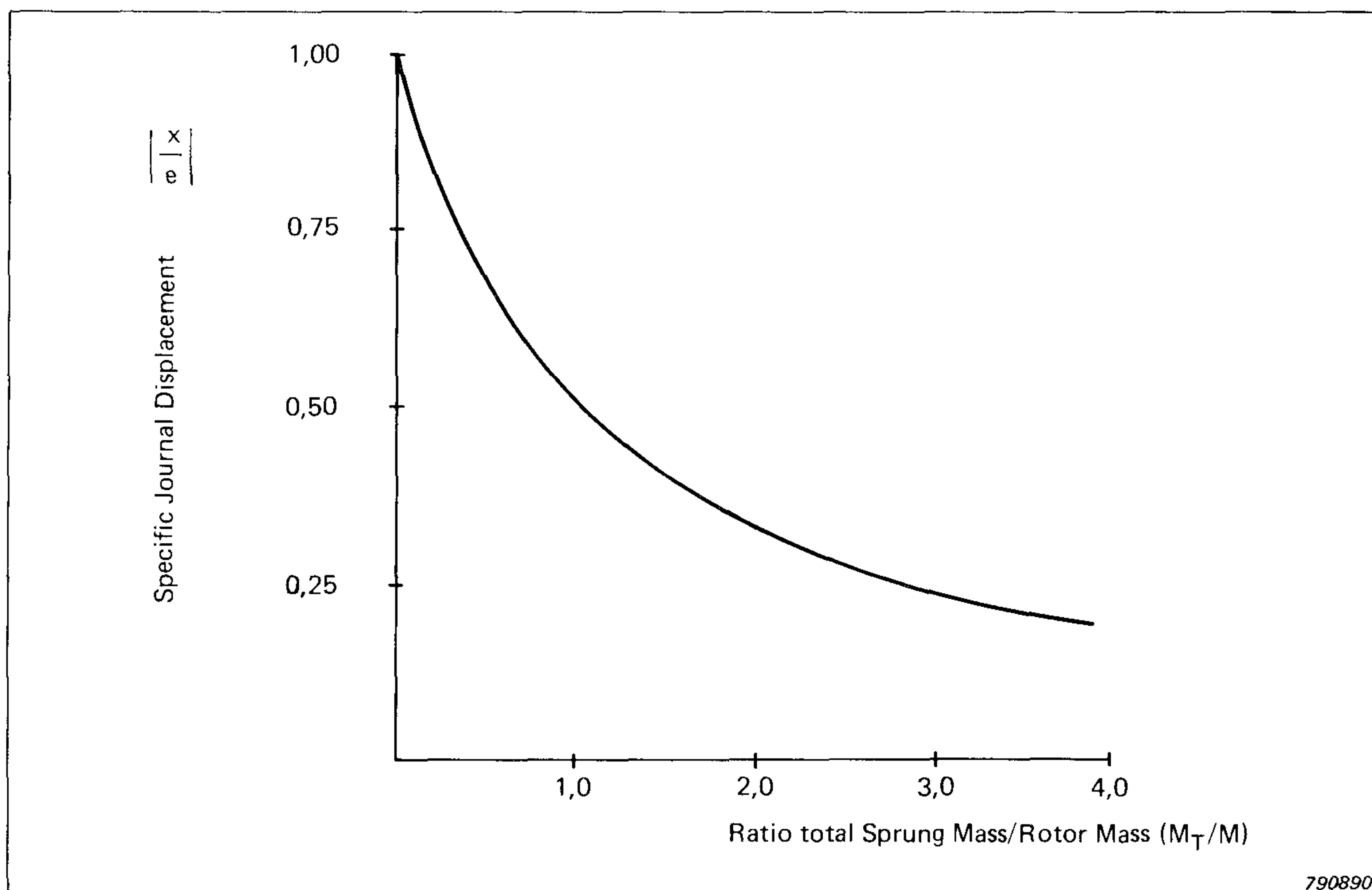

Fig.8. Effect of reduced rotor mass on measured displacement

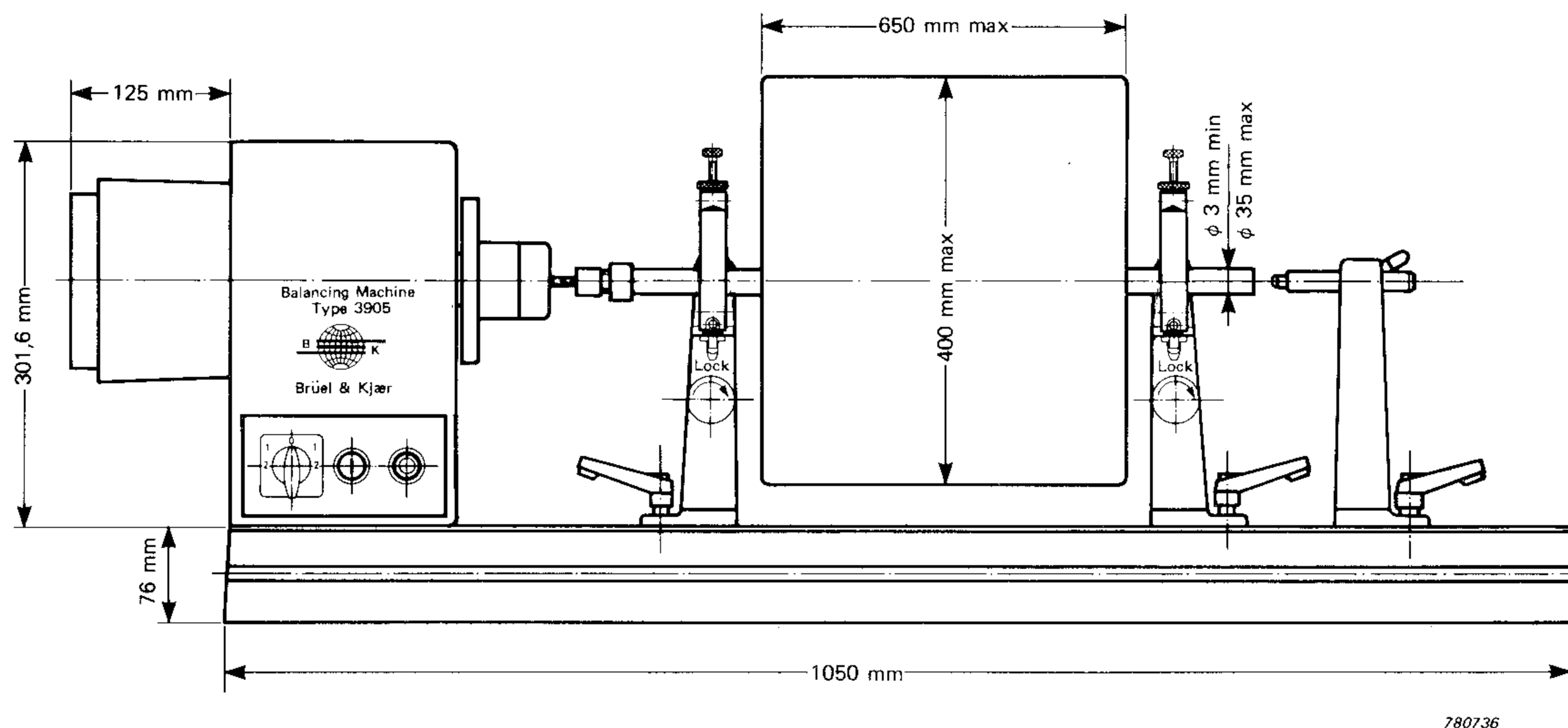

Fig.9. Type 3905 Balancing Machine. Maximum rotor dimensions in mm

The traditional universal horizontal dynamic balancing machine comprises two support pedestals, in which the measuring elements are housed, whose positions are adjustable along the length of a sturdy base-plate. (Fig. 9). Further versatility is available in the selection of journal bearings themselves (e.g. prism-, roller-, ball-bearings) and of the drive method (e.g. cardan shaft, belt, air, magnetic). These adjustments enable optimal measuring positions to be set up. Unfortunate positioning of measuring planes near the centre of mass, which would make balancing difficult, is avoided: the measuring sensors can be arranged to give signals readily referred to the two correction planes to be used: journal bearings and drive system can be selected consistent with the precision or work rate required.

This adjustment is particularly important to obtain the best results from the measuring electronics, which inevitably have defined limits on signal to noise ratio performance and dynamic range. Reference to equation (5) shows that when using the plane separators, it is important to relate each correction plane to its "major" associated measuring plane: when using the plane separators it is only possible to introduce a proportion of this signal to the "minor" measured signal. "Over-separation", so to speak, to enable the other principal diagonal of the matrix to be used, will not yield satisfactory results. A functional diagram of the plane separator circuit is shown in Fig.10. Association of correction plane with measuring plane does not normally pose problems as it becomes self-evident in the calibration runs, but some experimentation

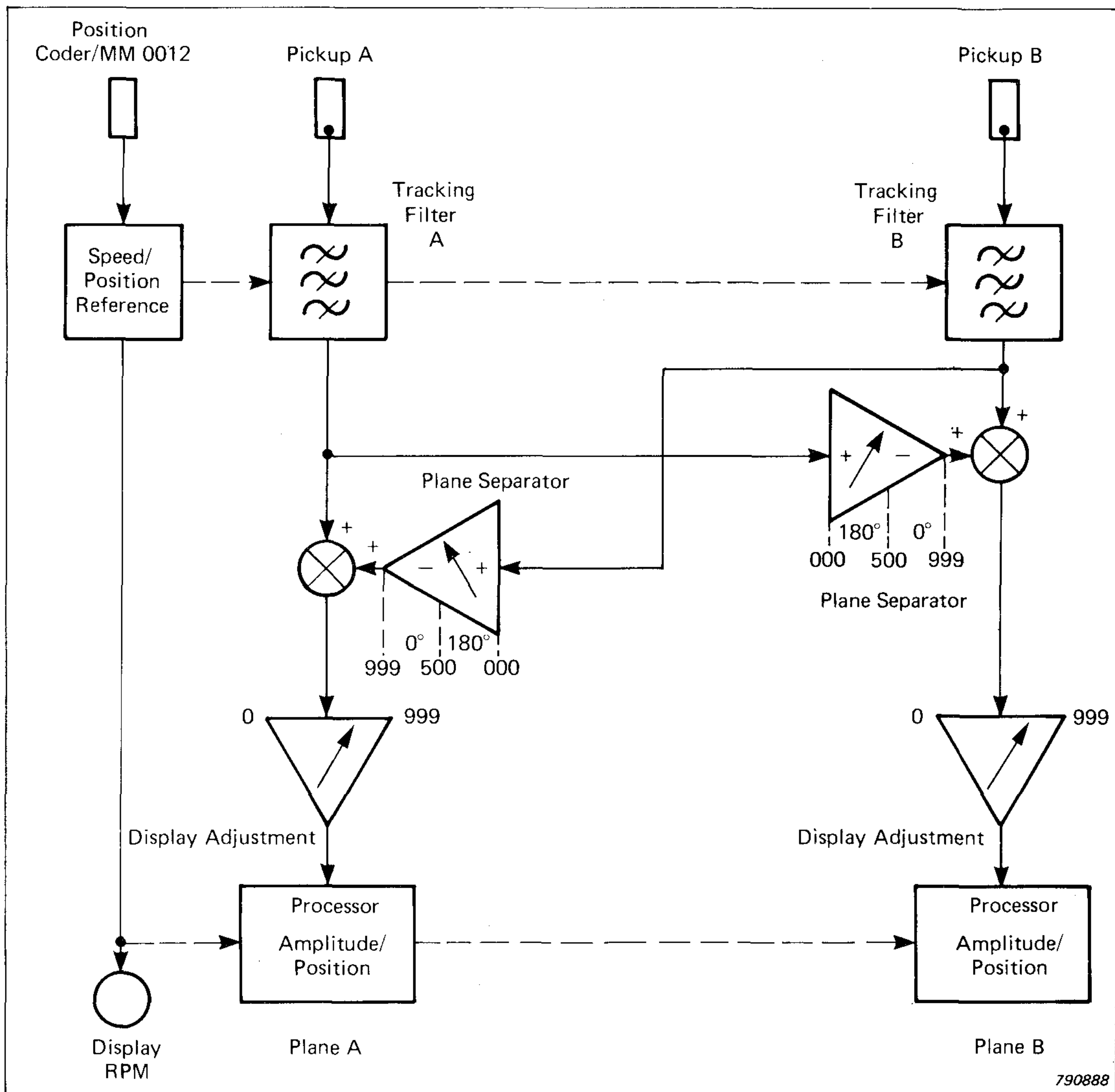

Fig.10. Functional Diagram of 2504 system

is sometimes required so that the Console processor is dealing with signals of similar magnitude.

A further feature of such electronics affects its use in other applications. Typical soft-bearing configurations with a horizontal measuring direction are shown in Fig.11. For a balancing machine application, the placing of unbalance on a balanced rotor will only evoke in-phase or anti-phase response in the two measuring planes. Stage (b) of Fig.3 is shown in Fig.12. In field balancing applications, not only will the support systems be quite unknown, but their loading and resonances end for end are likely to be completely different. A model of this situation

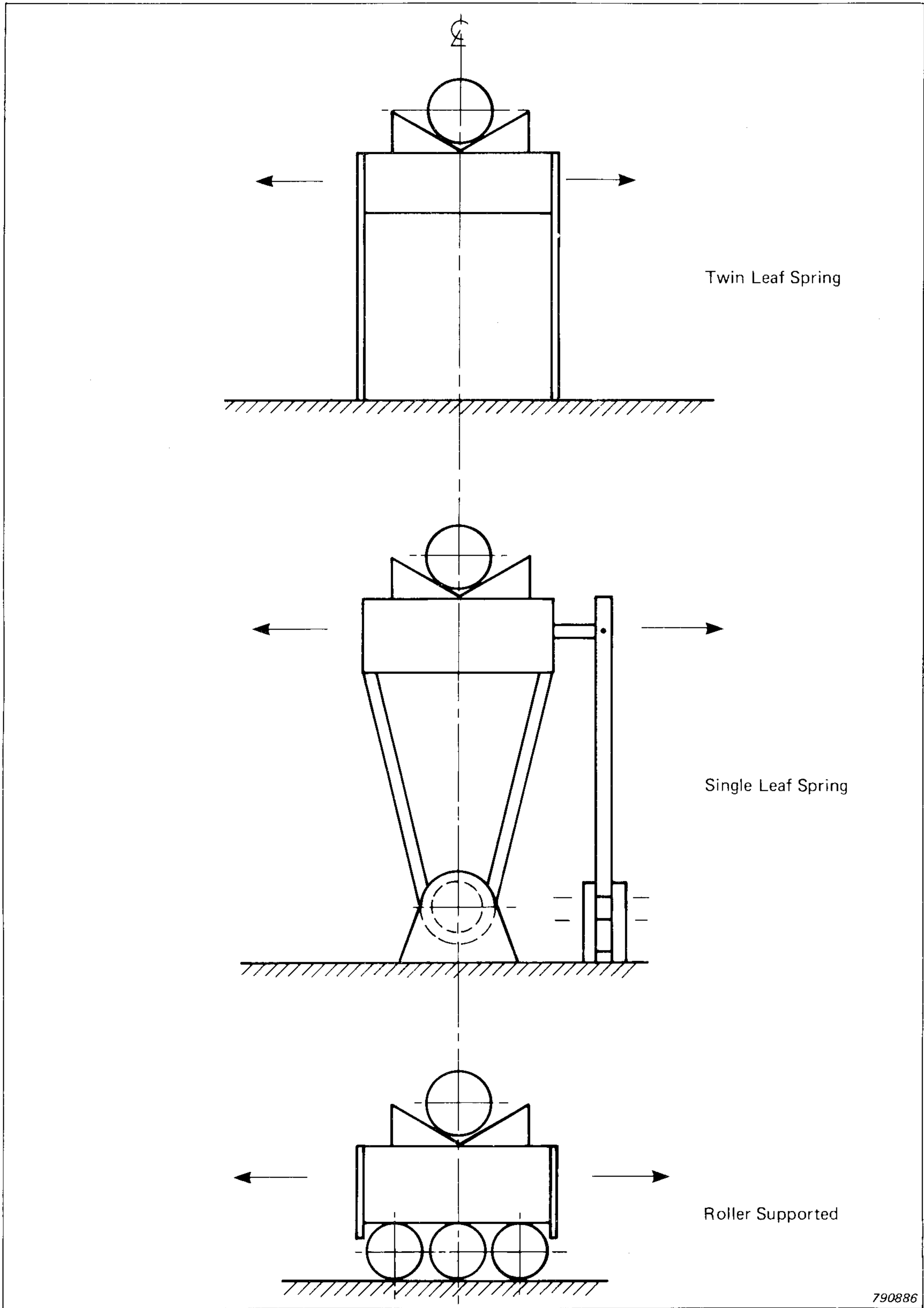

Fig.11. Examples of soft suspension types

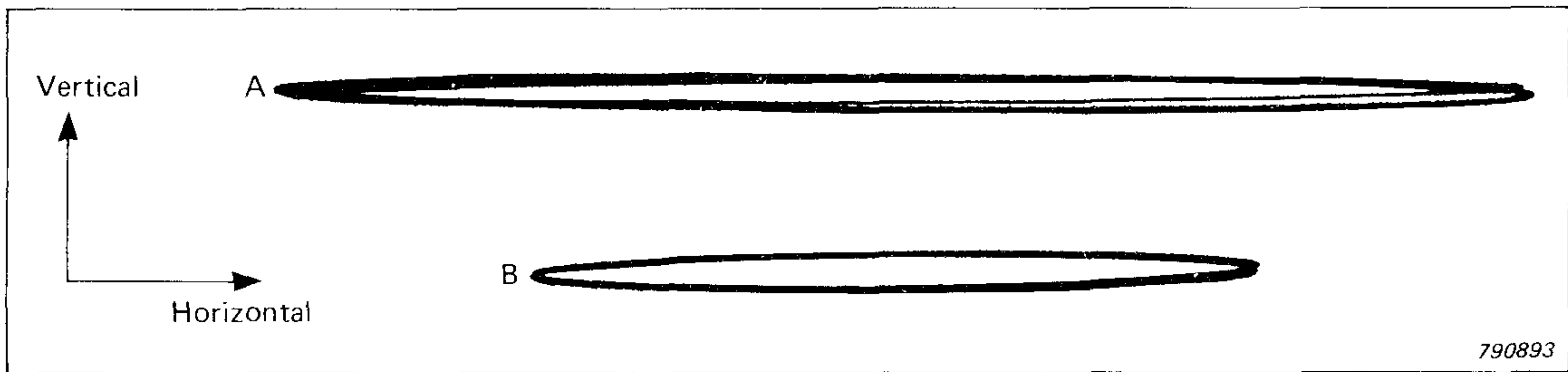

Fig.12. *Vibration at support A and B on a balancing machine (Type 3905 at 3000 r.p.m.)*

is shown in Fig.13. Under particular operating conditions, a 90° response might be observed when placing a similar trial unbalance, as shown in Fig.14; alternatively it might be impractical to mount the transducers with parallel measuring axes. Clearly the plane separators cannot eliminate cross-influences in such cases. With reference to (3) and (5), it may be said that complex terms in $[\alpha]$ cannot be generated, but simply magnitude and polarity. Leading diagonal terms are adjusted to unity, and off-diagonal terms to zero: different properties are non-allowable.

However, adjustment of the mechanical system — location of centre of

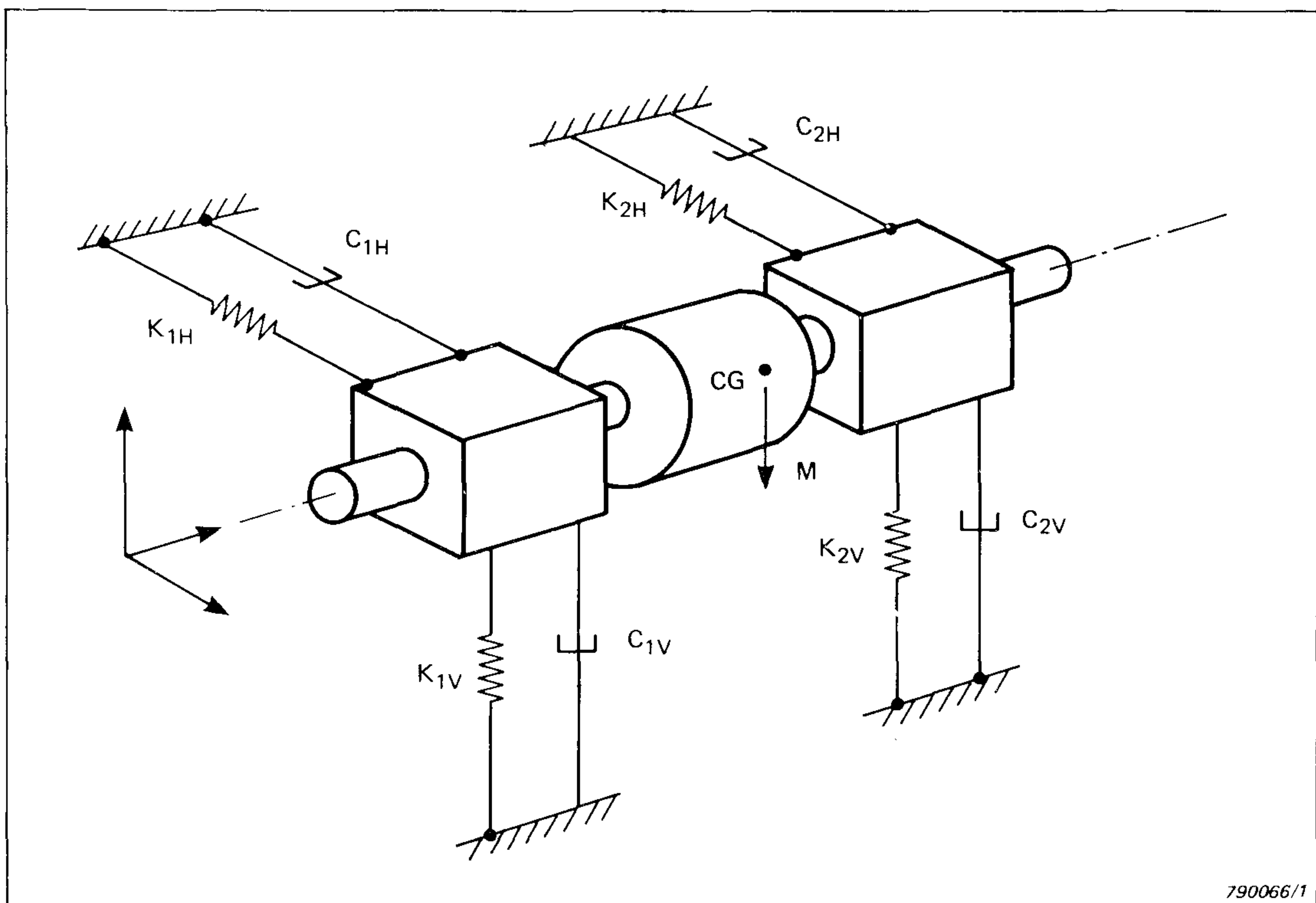

Fig.13. *Linear Model of complete machine*

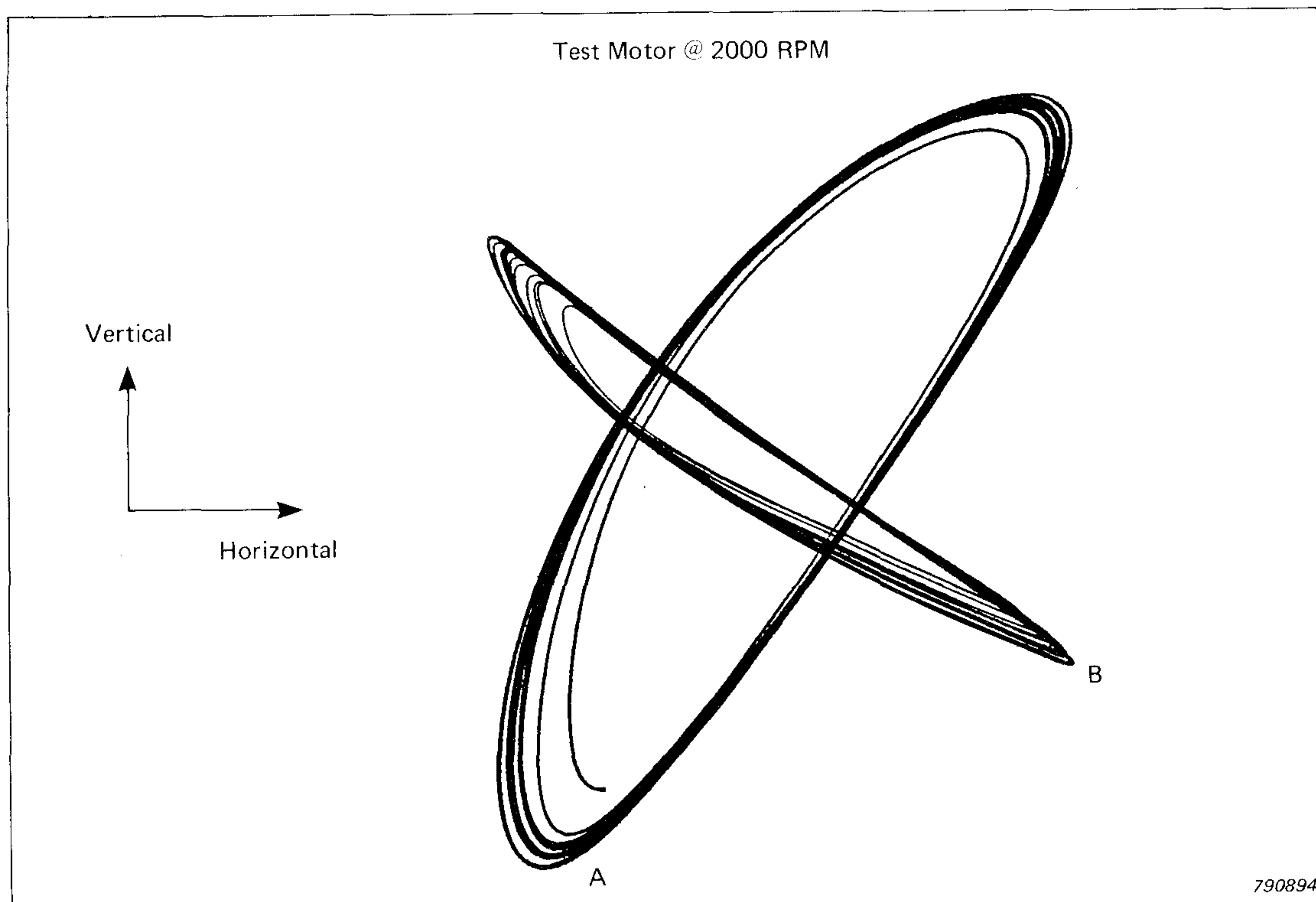

Fig.14. Vibration at support A and B on a test motor (Test motor at 2000 r.p.m.)

mass, positioning of measuring planes, choice of correction planes, selection of bearing and journal types — to provide acceptable signals for the Console enables a very rapid method of rotor balancing to be achieved without ambiguity.

Comments on The Field Balancing Approach

Field balancing performs a complementary role. Balancing machines enable rapid balancing of single items within specified tolerances. However, these single items are usually assembled subsequently into a complete system. The balancing of rotating assemblies must almost inevitably be performed on-site at the commissioning stage, following replacement of component parts, following relative shifting of shaft-mounted components, or due to localised erosion or corrosion. Measured vibration in-situ does not comprise merely mal-distributed mass, but also other sources, including synchronous frequency components which may be described as quasi-unbalance effects. Typical quasi-unbalance sources for otherwise balance components are shown in Fig.15 for an electric machine with a geometric offset on the windings (a), or poorly machined drive couplings (b), (c). Provided these components are phase locked to the primary rotating element, balancing techniques can be

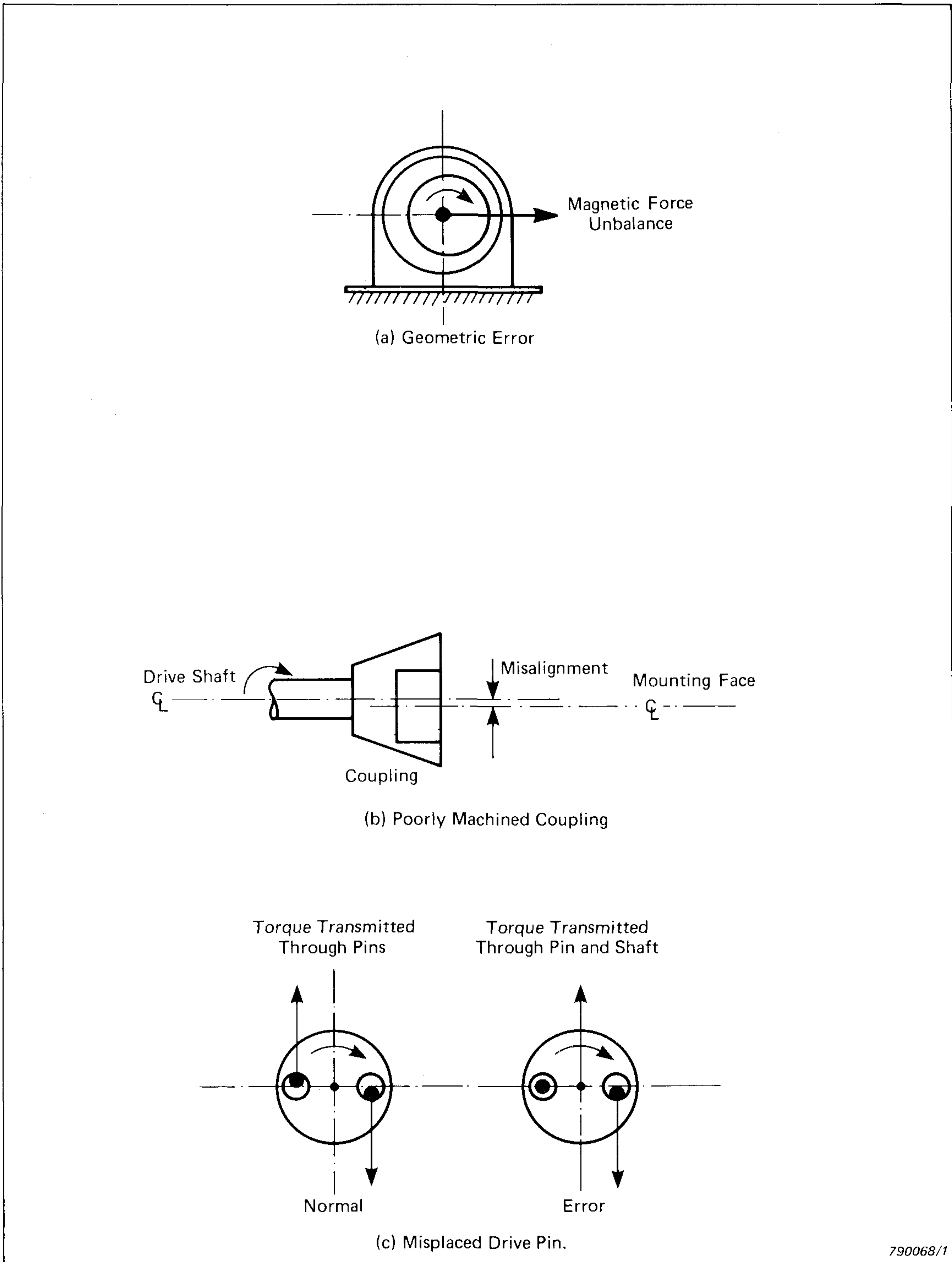

Fig.15. Same quasi-unbalance sources

used to reduce the vibration vector synchronous with shaft rotation. It is important to note that all vibration over a wide frequency spectrum will be measured, including higher order harmonics due to shaft mis-

alignment, blade passing frequency, etc. and non phase locked synchronous components such as drive belts and chains with non-uniform line density. The former can be removed by filtering, whilst the latter may require overhaul of the drive system. Certainly the principal components in the vibration velocity spectrum should be established, as balancing will not reduce components which are independent of the magnitude of the fundamental.

Fortunately, when the requirement is simply to measure amplitude and relative phase of a vibration signal, some of the limitations of a "universal" balancing machine are avoided. The externally measured vibration levels will be lower than those on a balancing machine (except for the unfortunate case of an assembled machine operating near a support resonance) due to the attenuation afforded by the associated mass of the machine, and spring and damper elements. However, the measuring transducer, and the measuring instrument itself can be optimised for each and every one of the 6 vibration vectors in a calibration run. This is advantageous as selection of measuring and correction planes is limited on an assembled machine.

The run quality of the assembled machine comprising these mass, spring, and damper elements is best represented by a vibration velocity criterion, and typical recommended levels are quoted for certain machine types in ISO 2372 and VDI 2056: in these standards it is the vibration energy, and its damaging potential which is of prime interest so rms velocity in mms^{-1} summed over a range 10 Hz to 1000 Hz is a useful parameter. When it has been established that a predetermined value has been exceeded, and balancing is necessary, acceleration velocity or displacement can be selected, as convenient, to achieve the best extraneous vibration rejection in the balancing runs. Use of ISO 1940 and VDI 2060 can be of great assistance for a rapid selection of representative trial unbalance for particular rotor mass.

A typical table of results is shown in Table 1. All analysis can be performed numerically by calculator: the calculating range may be 10^{-99} to 10^{99} (4000 dB) or greater, thus affording good accuracy even with signals of widely differing amplitude. It is quite simple to analyse signals in either polar or cartesian form without limitations to physical response between respective planes. In fact, it is immaterial how measuring and correction planes are indexed, provided a consistent approach is adopted. The first index indicates measuring plane, and the second the correction plane used: the alternative plane selection for vectors in Table 1 is shown in Table 2 to give exactly the same result.

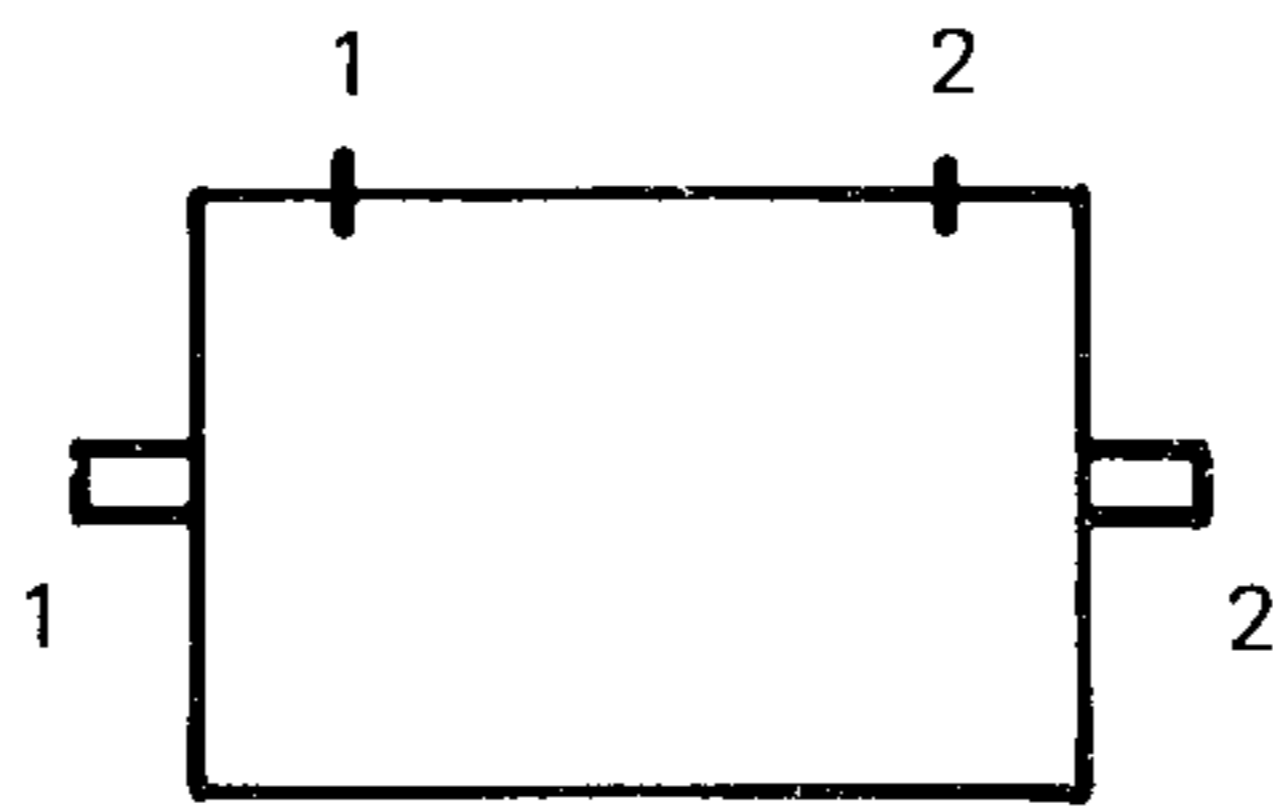

Trial Mass Size and Location	Measured Effect of Trial Mass					
	Plane 1			Plane 2		
None	7,2 mm/s	238°	\bar{V}_{10}	13,5 mm/s	296°	\bar{V}_{20}
2,5 g on Plane 1	4,9 mm/s	114°	\bar{V}_{11}	9,2 mm/s	347°	\bar{V}_{21}
2,5 g on Plane 2	4,0 mm/s	79°	\bar{V}_{12}	12,0 mm/s	292°	\bar{V}_{22}
Correction	2,95 g	50,2°		2,84 g	-81,8°	

790683

Table 1. Typical measurement sequence for in-situ balancing

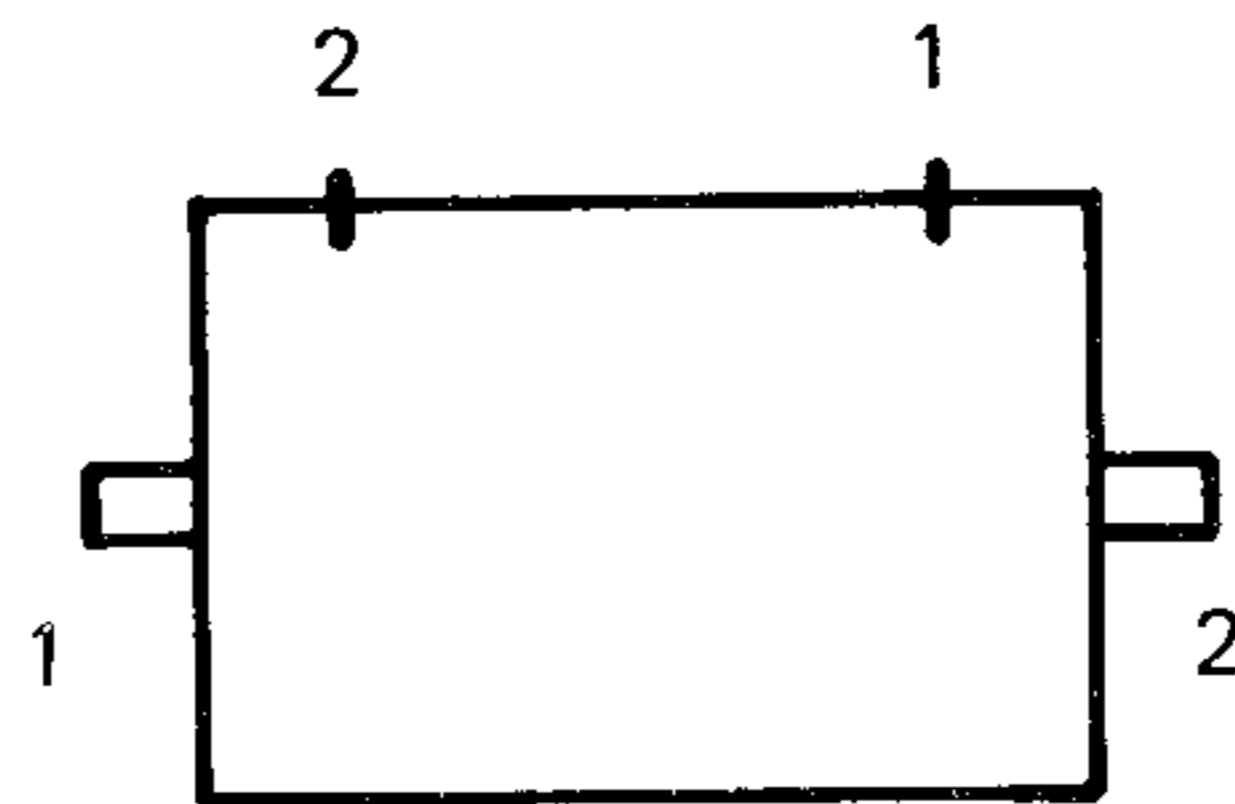

Trial Mass Size and Location	Measured Effect of Trial Mass					
	Plane 1			Plane 2		
None	7,2 mm/s	238°	\bar{V}_{10}	13,5 mm/s	296°	\bar{V}_{20}
2,5 g Plane 2	4,9 mm/s	114°	\bar{V}_{12}	9,2 mm/s	347°	\bar{V}_{22}
2,5 g Plane 1	4,0 mm/s	79°	\bar{V}_{11}	12,0 mm/s	292°	\bar{V}_{21}
Correction	2,84 g	-81,8°		2,95 g	50,2°	

790682

Table 2. Measurement sequence as for Table 1 using alternative reference

Where support characteristics remain constant, and where it is possible to ensure that the relative positioning of the sensors remains the same,

further development of the relationships in (6) and (7) can be advantageous. By referencing the test unbalances U_{T1} , and U_{T2} to the trigger position, they can be given vector designations \bar{U}_{T1} , \bar{U}_{T2} . Whereas in (8) calculated corrections are referred to the trial unbalance positions (most practical in many applications as this is physical and unambiguous) such a development using \bar{U}_{T1} and \bar{U}_{T2} will refer corrections to the trigger point. Now the matrix $[\bar{\alpha}]$ can be used quite generally for repeat balancing on the same machine, or for first time balancing of physically identical machines under certain conditions. It requires careful assessment to ensure consistent response and consistent measurement locations, which are essential to enable this technique to be used for any initial values \bar{V}_1 , \bar{V}_2 on the machine.

Similarly, where calibrations are made by unbalance changes which cannot be rescinded at subsequent stages, this is a programming refinement to enable generation of the terms in $[\bar{\alpha}]$. Where \bar{V}_{10} , \bar{V}_{20} become \bar{V}_{11} , \bar{V}_{21} , which in turn become \bar{V}_{12} and \bar{V}_{22} without returning to the initial condition, relationships (7) must be written:

$$\left(\bar{V}_{12} - \bar{V}_{11}\right) = \alpha_{12}\bar{U}_{T2} \quad \left(\bar{V}_{22} - \bar{V}_{21}\right) = \alpha_{22}\bar{U}_{T2} \quad (9)$$

whilst the state to be corrected has become \bar{V}_{12} , \bar{V}_{22} . So (8) should be written:

$$\begin{pmatrix} \bar{U}_{C1} \\ \bar{U}_{C2} \end{pmatrix} = - \left[\bar{\alpha} \right]^{-1} \begin{pmatrix} \bar{V}_{12} \\ \bar{V}_{22} \end{pmatrix} \quad (10)$$

A block diagram of a pocket calculator program which allows selection of these procedure options at choice, and allows output of the matrix $[\alpha]$ for subsequent use, is shown in Fig.16.

In the field balancing situation, the limitations are with the physical construction of the machine. The flexibility lies with the analysis itself which is completely divorced from the measurements themselves. It is not limited in the number of measuring points, and could be extended to multi- plane balancing of flexible shafts: the limitation is then to ensure linear system response and phase fidelity, and the extra computation required to obtain the results. Certainly the use of this approach requires greater comprehension on the part of the user.

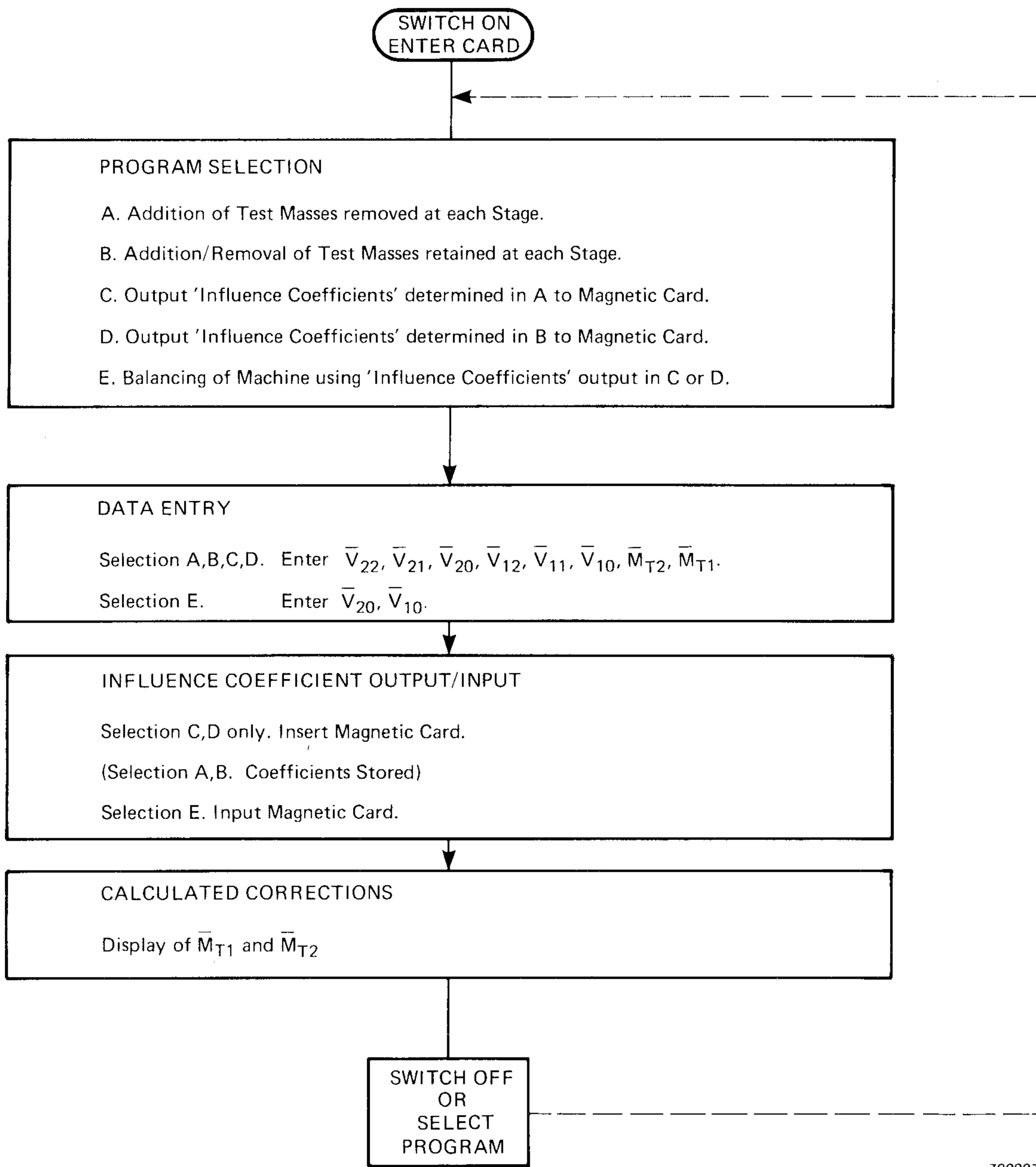

790887

Fig.16. Block diagram of 2-plane program developed for pocket calculator

Conclusions

The concept of an influence coefficient matrix can be of great assistance in visualizing the analysis problem of dynamic balancing by vibration measurement in two planes, whether it is solved by electronic, graphical or numerical means.

On a balancing machine, considerable flexibility is afforded in the selection of mechanical layout — plane location, support method, and drive system. This is important to ensure that the electronic Console receives signals with which it can operate efficiently and repeatably. Once set up, the system can be operated quickly, perhaps in semi-automatic or fully-automatic operation, without ambiguity for repeat balancing on similar rotors.

In field balancing, the physical construction of the machine limits the possibilities for measurement severely. However, optimal selection of measuring equipment and use of numerical analysis techniques affords a very flexible balancing capability, and one equipment can be used for measurements of machines of widely differing size, rotational speed, and mass. The greater complexity of data handling and subsequent calculation can make this operation slightly more complicated for the unskilled technician.

In the discussion electronic processing, and numerical analysis have been very distinctly separated to illustrate various points. With the rapid growth in the use of digital electronics the overlap between the applications of the techniques will become ever greater so that the full numerical capability of a calculator will be combined with the ease of use of current balancing electronic units.

References

- | | |
|----------|---|
| ISO-1940 | Balancing Quality of Rotating Rigid Bodies |
| VDI-2060 | Beurteilungsmaßstäbe für den Auswuchtzustand rotierender starrer Körper |
| ISO-2372 | Mechanical Vibration of Machines with Operating Speeds from 10 to 200 r/s |
| VDI-2056 | Beurteilungsmaßstäbe für mechanische Schwingungen von Maschinen |

Brief Communication

The intention of this section in the B & K Technical Reviews is to cover more practical aspects of the use of Brüel & Kjær instruments. It is meant to be an "open forum" for communication between the readers of the Review and our development and application laboratories. We therefore invite you to contribute to this communication whenever you have solved a measurement problem that you think may be of general interest to users of B & K equipment. The only restriction to contributions is that they should be as short as possible and preferably no longer than 3 typewritten pages (A4).

Interfacing Level Recorder Type 2306 to a Digital Computer

by

*M. M. Boone**

Introduction

When using digital computers for acoustic data analysis, it is often desirable to present the results in a graphical form on a level recorder chart for the following reasons:

1. Graphical results are easily interpreted by most acousticians
2. As the level recorder chart is precalibrated in dB against log frequency axis, only the data curve needs to be plotted.

This article describes how a Level Recorder Type 2306 can be interfaced to any digital computer for obtaining a graphical output.

* Department of Applied Physics; University of Technology P. O. B. 5046. 2600 GA Delft. Netherlands

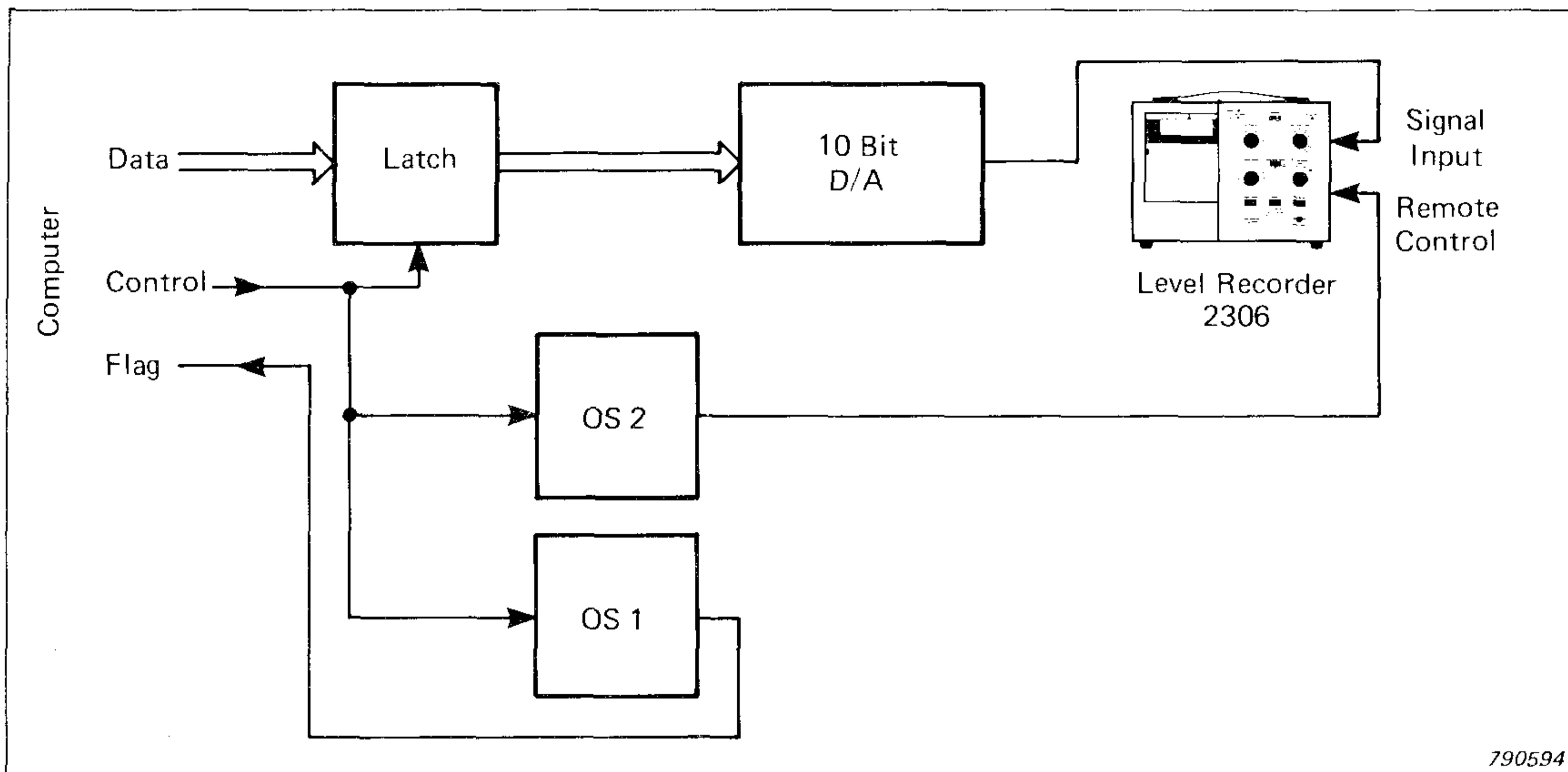

Fig. 1. Block diagram of the Interface

Interfacing Procedure

Fig. 1 shows a block diagram of the interface. The computer is equipped with a standard parallel digital interface with a control line to indicate that the data is ready for output and a flag line to let the computer know that the data is accepted.

The digital data from the computer is stored in a one-word buffer (latch), which through a D/A converter (10 bits is sufficient for this purpose) is fed to the input of the level recorder.

As a step motor is used, the paper transport of the Level Recorder 2306 is straightforward. With the PAPER SPEED switch on Ext. the remote control can be used to activate the motor using TTL levels. The motor steps 1/8 mm for each TTL pulse the duration of which must be at least 2 ms.

The data transfer rate of the digital output is controlled by OS 1. A satisfactory response to almost any data curve can be obtained with a paper speed of 3 mm/s, thus OS1 must give a flag delay of 40 ms. The computer output being very fast, the flag signal itself cannot drive the remote control; the level recorder would not be able to distinguish the small interval between the pulses. This can be overcome by using a second one-shot (OS2) with a pulse duration of 5 ms, see Fig. 2.

If the computer is already equipped with a D/A converter, only the timing circuits have to be installed. It is recommended that the level re-

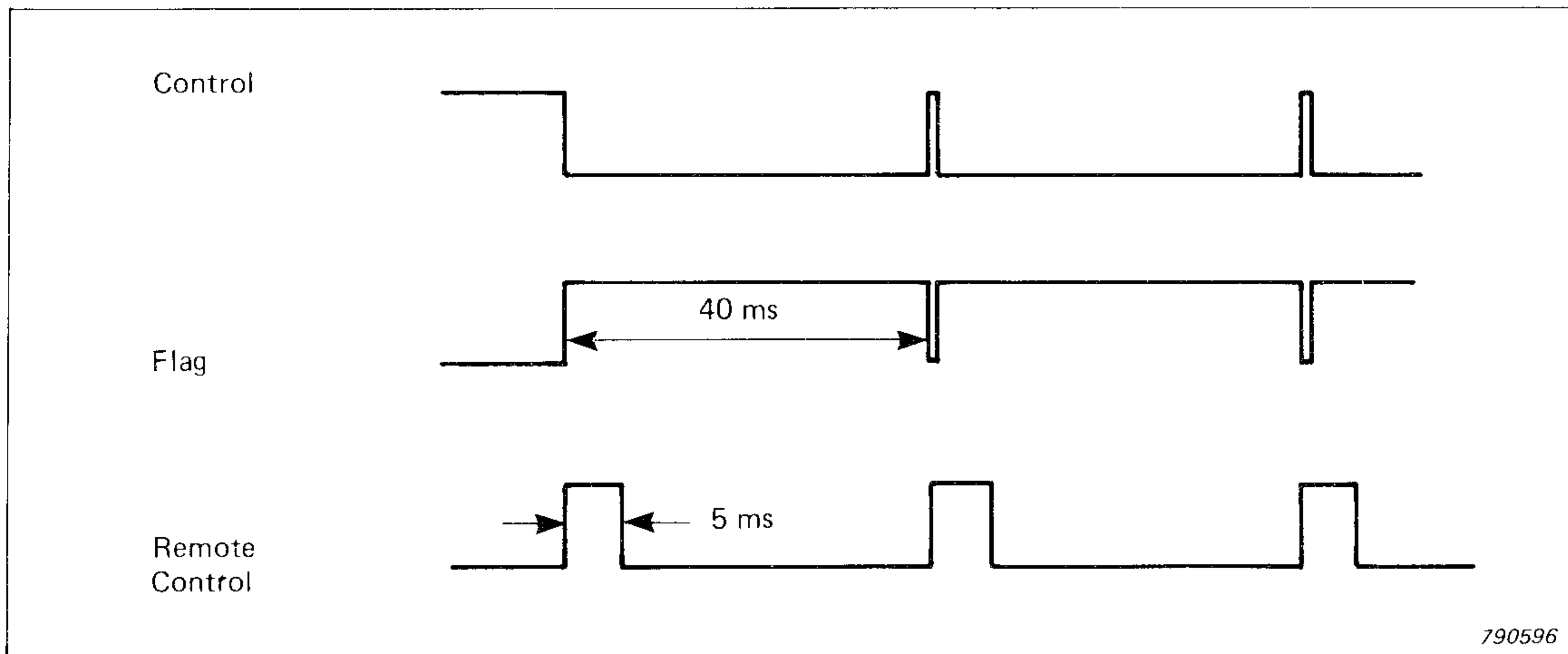

Fig.2. Timing diagram of the Interface

order should be used in the DC-Lin mode. For a 10 bit D/A converter, the output ranges from 0 to 511 corresponding to min. and max. on the recording paper. The recorder can be calibrated to these limits with "DC Lin Position" and "Sensitivity" potentiometers. If the output is off-scale on the lower side a small negative value can be sent for indication. If the output is too large the data is clipped at 511.

All data conversion is carried out by software, for example conversion to log scale for dBs. When the frequency calibrated paper QP 0124 is used the plot is started at the normal starting point and will end after 250 mm equivalent to 2000 data points.

Practical Examples

Fig.3 illustrates the use of a log-log scale. The impulse response of a small loudspeaker was sampled with a sampling frequency of 50 kHz.

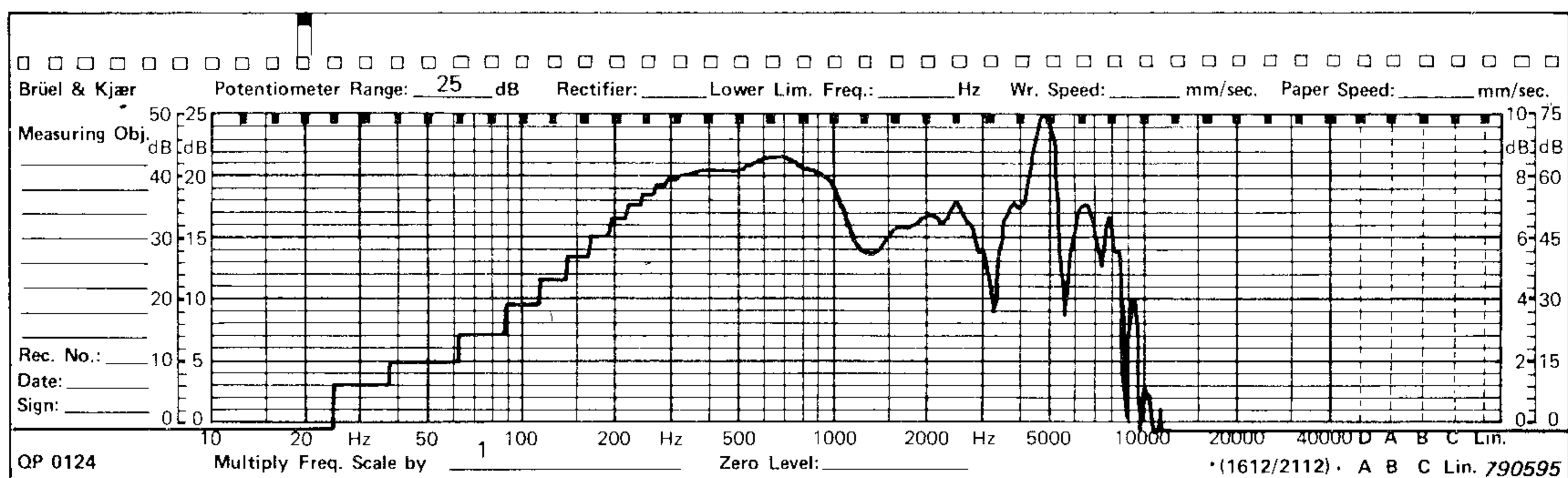

Fig.3. Amplitude response of a loudspeaker, computed from impulse response

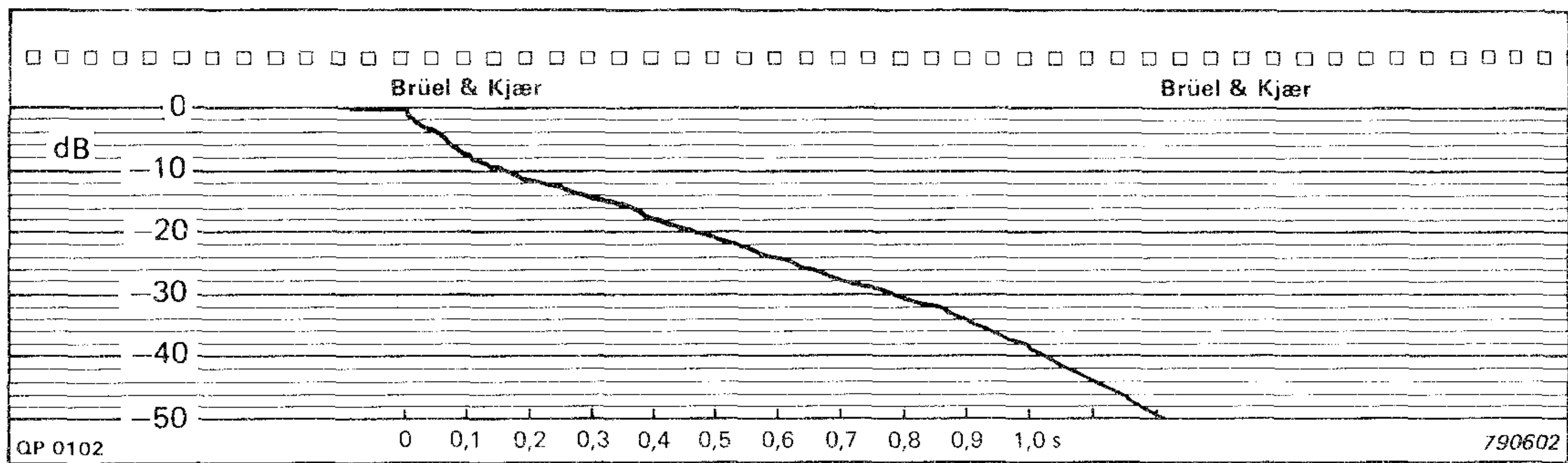

Fig.4. Reverberation curve of a concert hall, computed from impulse response

The amplitude response was computed using an FFT algorithm of 2048 points. Note the unequal spacing of the computed frequency points on account of the log frequency axis. In this example a "25 dB potentiometer" was computed in combination with autoscaling.

Fig.4 shows a reverberation curve of a concert hall, computed from the impulse response using the Schroeder-method. A "50 dB software potentiometer" was used in this case.

News from the Factory

Two-Plane Balancing Equipment Types 2504 and 3905

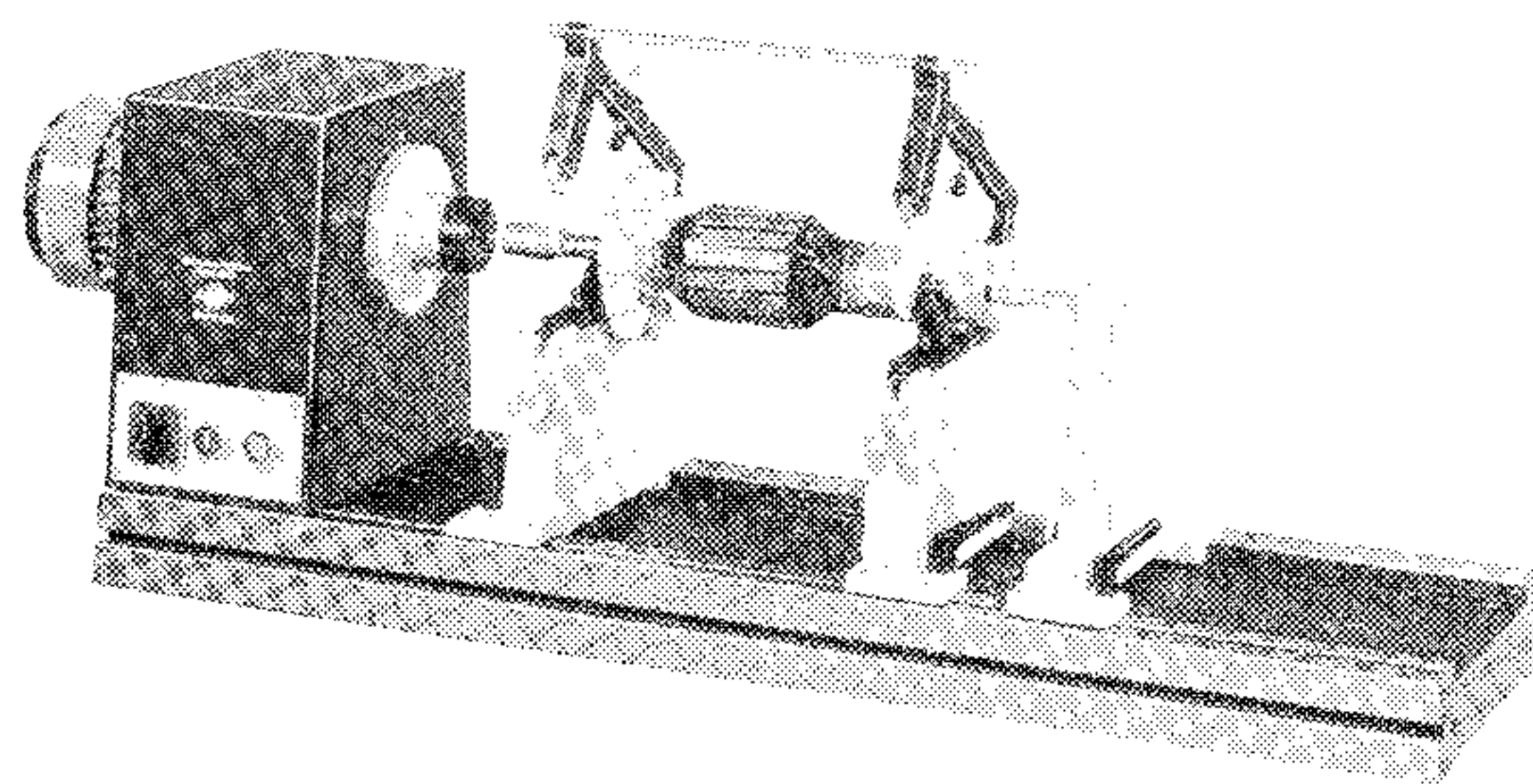
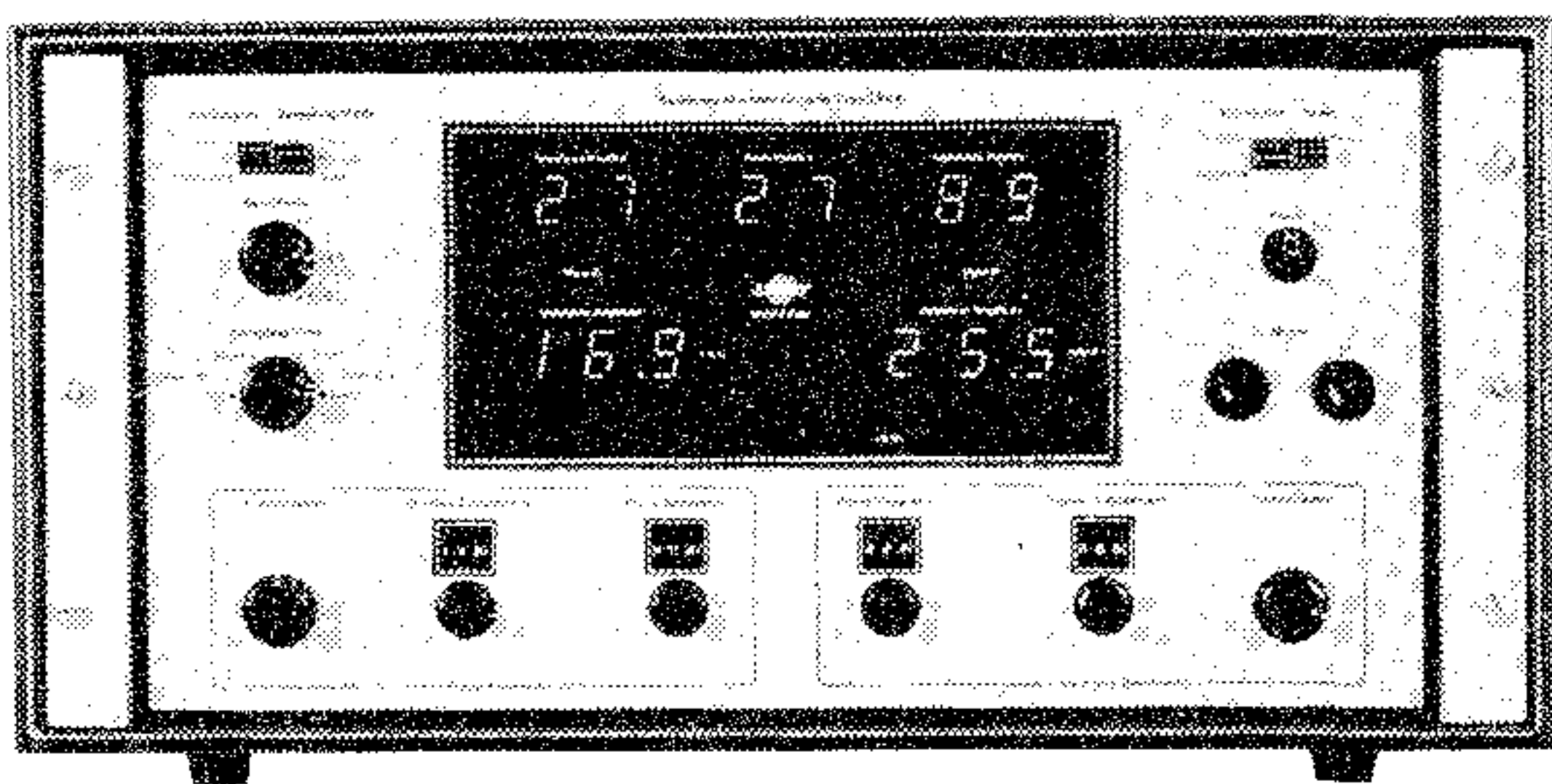

The B & K Two-Plane Balancing Equipment is designed for balancing on the production line of series-manufactured rotating components. It permits unbalance at each bearing to be reduced to the order of 0,5 mm/s (0,02 in/s), which is less than quality grades G1 and Q1 as defined for static unbalance in ISO 1940 and VDI 2060 respectively.

The equipment consists of two units, the Balancing Machine Type 3905 which may be used to balance work pieces weighing up to 10 kg (22 lb) and the measuring Console Type 2504 which calculates the corrections required to bring the rotor into balance.

The Balancing Machine Type 3905 consists of a heavy cast iron (Meehanite) base-plate, incorporating machined bed ways, and carrying all the operational components. It supports the rotor to be balanced in a pair of bearings (each with a rated load of 5 kg) mounted on horizontally compliant suspensions, whose movements are measured by a pair of transducers.

A two-speed 3-phase squirrelcage motor is used for rapid run-up and shut-down. It drives the rotor to be balanced through a cardan shaft de-

signed to minimise drive-generated vibration. Also carried on the motor shaft is an angle reference generator and a local rotor angle indicator. The generator is an optical 7-bit binary code generator transmitting a synchronizing signal to the Console Type 2504, where the shaft angle is displayed as a two-character, illuminated number, in hundredths of a revolution. The local angle indicator consists of a graduated drum divided into ten 36° increments and shows reference zero.

The nominal motor speeds are 1500 and 3000 RPM on 50 Hz supplies, and 1800 and 3600 RPM on 60 Hz supplies. The rated powers are 0,33 and 0,55 kW at the lower and higher speed respectively. Local "Stop" and "Start" buttons are provided at the base of the motor pedestal (as well as similar remote buttons on the Type 2504 Balancing Machine Console). A speed and direction switch is also provided at the base of the pedestal.

The balancing machine is of the soft bearing type which gives increased sensitivity, reduces the demands placed on the rigidity of the foundation and increases operator confidence by enabling unbalance to be seen as well as measured.

The Balancing Machine Console Type 2504 processes the two vibration signals from the two bearings of the Balancing Machine and correlates these with the signal from the angle reference generator in order to display both the magnitude and orientation of unbalance in each of the chosen correction planes (which are normally different from the bearing planes). It also displays the instantaneous shaft angle (Rotor Position) when the motor is switched off, and the actual motor speed to the nearest RPM. The five main items are displayed in easy-to-read illuminated LED characters 16 mm (5/8 in) high.

The Console also carries multi-turn adjustments for removal of mutual interaction between correction planes (which is dependent on the correction plane positions), setting the practical correction units (e.g., grammes, ounces etc.), and adjusting the amount of compensation needed to simulate a balanced rotor for initial calibration purposes. The Unbalance Amplitude displays may be set by the operator to indicate either the chosen correction units, or vibration level at the bearings, in mm s^{-1} , without interfering with the calibration.

The Type 2504 Balancing Machine Console may be used in installations which do not incorporate a Type 3905 Balancing Machine. It is suitable for upgrading an existing facility, when it may be connected to

an existing machine; or for balancing work pieces requiring customized mechanical equipment. The 2504 is also well suited to incorporation by OEMs (Original Equipment Manufacturers) as a system component in other balancing installations.

Portable Balancing Set Type 9500

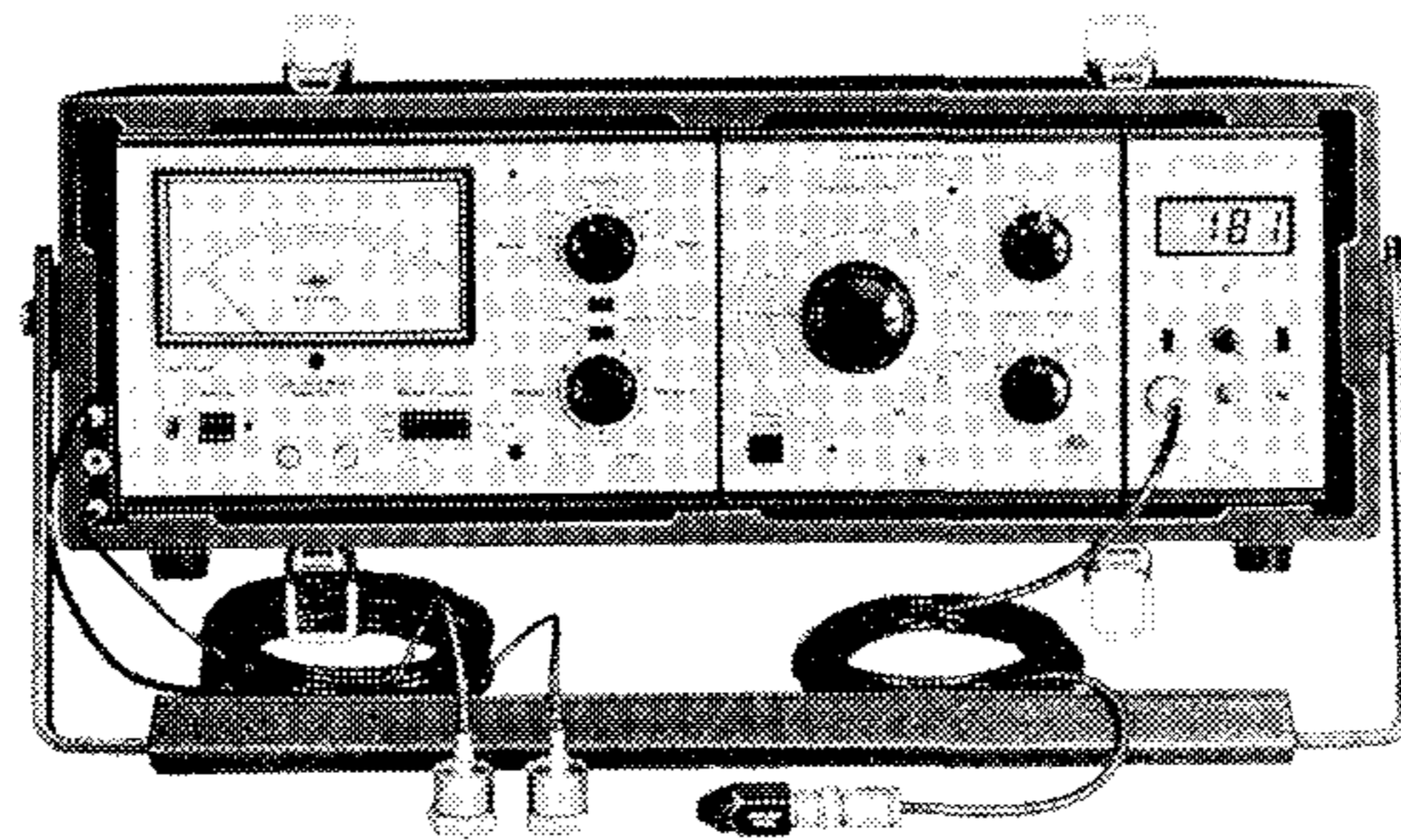

This fully Portable Dynamic Balancing Set brings together, in a single readily transported carrying case, all the components necessary for making the vibration and angle measurements required in the dynamic balancing of a machine running in its own bearings.

It can be used for both simple single plane balancing of, for example, flywheels and grinding wheels, and also for "Dynamic" two-plane balancing of rotating parts having distributed mass along a shaft. The method does away with strobe lights and the manual plotting of vector diagrams, the rather complicated two-plane balancing calculation is performed by a programmable pocket calculator. Ready programmed magnetic memory cards are available from B & K for the Texas Instruments SR 52 and SR 59 and the Hewlett-Packard HP 67 and HP 97 calculators. The balancing set is equally suitable for multi-plane balancing where high resolution and accuracy is even more important, but larger calculators are needed.

The Balancing Set which is contained in a robust hard foam carrying case consists of

- a) General Purpose Vibration Meter Type 2511, which conditions the signal from the vibration pick-up, Accelerometer Type 4370, and displays the unbalance amplitude.
- b) Tunable Filter Type 1621, which ensures that measurements are

made at the rotational frequency only and suppresses other vibration components.

- c) Trigger Unit Type 5767, which conditions the synchronisation signal from the Photoelectric Tachometer Probe MM 0012 and gives a precise digital display of the angular position of the out-of-balance force on the rotor.

As the Balancing Set 9500 is based on the General Purpose Vibration Meter/Analyzer Set Type 3513 it is also valuable for machine condition monitoring and the troubleshooting of vibration problems in running machinery.

Sound Power Calculator Type 7507

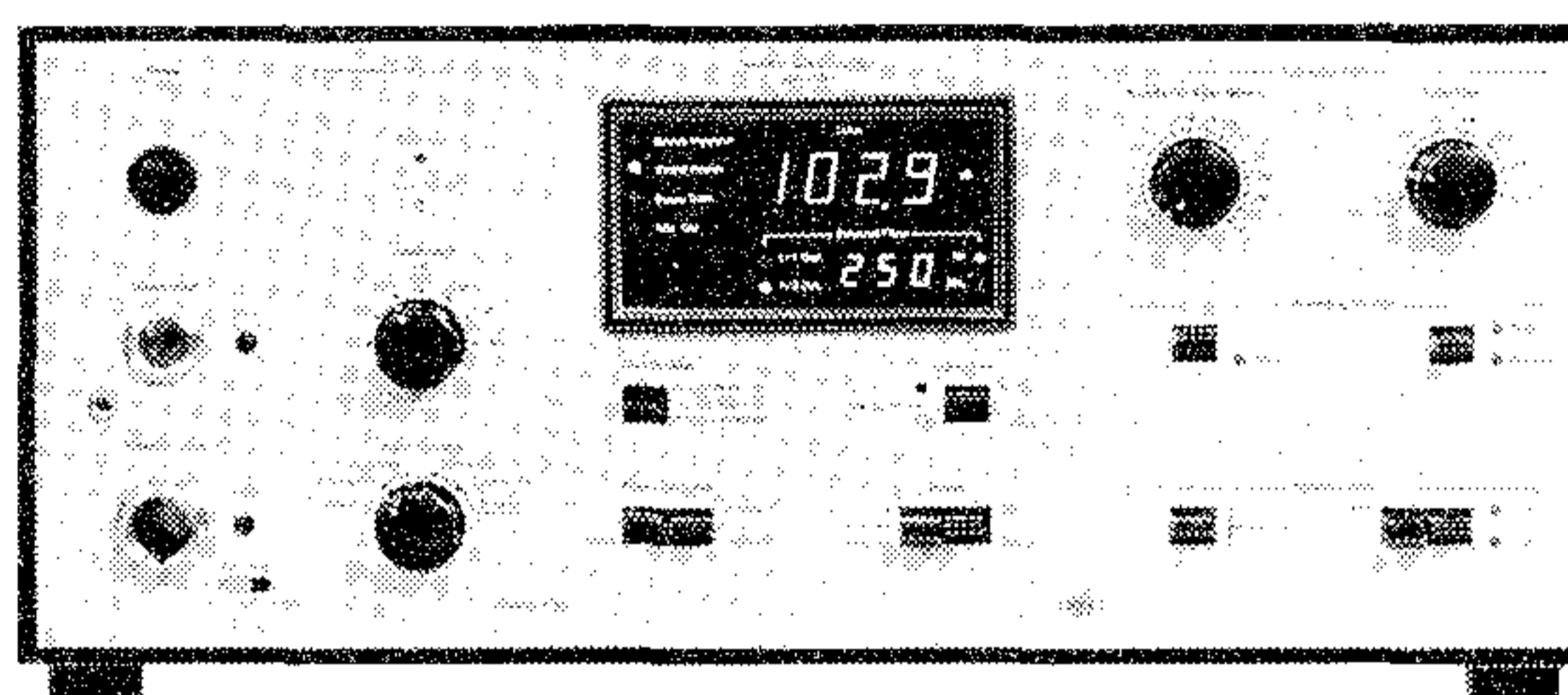

The Sound Power Calculator Type 7507 is primarily intended for automatic determination of sound power levels in octave or 1/3 octave bands or the A weighted level according to ISO 3741—3745, DIN 45 635, ANSI S1.21-1972 and ASHRAE 36-72 standards.

The 7507 has two inputs, a microphone input for use with a rotating microphone boom (or a single microphone moved from position to position) and a direct input for use with an array of microphones and a multiplexer which can be remotely controlled. The input signal is analysed by a parallel bank of 21 third octave filters (100 Hz — 10 kHz) fulfilling the requirements of IEC 225, DIN 45 652 and ANSI S1.11-1966 and may be averaged linearly over 8, 16, 32, 64, 128, 256 or 512 s. These averaging times may be subdivided between 1 and 32 subintervals for allocating equal measurement times for each microphone or sound source position.

The "Room Correction" terms (which have to be added to the averaged sound pressure levels for obtaining sound power levels) are fed in manu-

ally into the instrument and stored by the use of flip switches. The 7507 has two memories, one for the spectrum of the sound source and the other for background noise spectrum. From the difference between the two spectra stored in these memories the background noise is automatically corrected for before the sound power levels are evaluated.

The digital display indicates in dB the "Room Correction" levels, the averaged sound pressure levels measured or the sound power levels calculated for each octave or third-octave band centre frequency displayed on the screen.

The sound pressure and sound power level spectra of both the background and source noise may be output to Level Recorders and X-Y Recorders. Calibration signals for X and Y scales are provided for calibration of the recording paper. The data may also be output via the built-in IEC Interface Bus to an Alphanumeric Printer Type 2312, a Digital Cassette Recorder Type 7400 or to a desk-top calculator if further manipulation of the data is required.

Wide Range Measuring Amplifier Type 2610

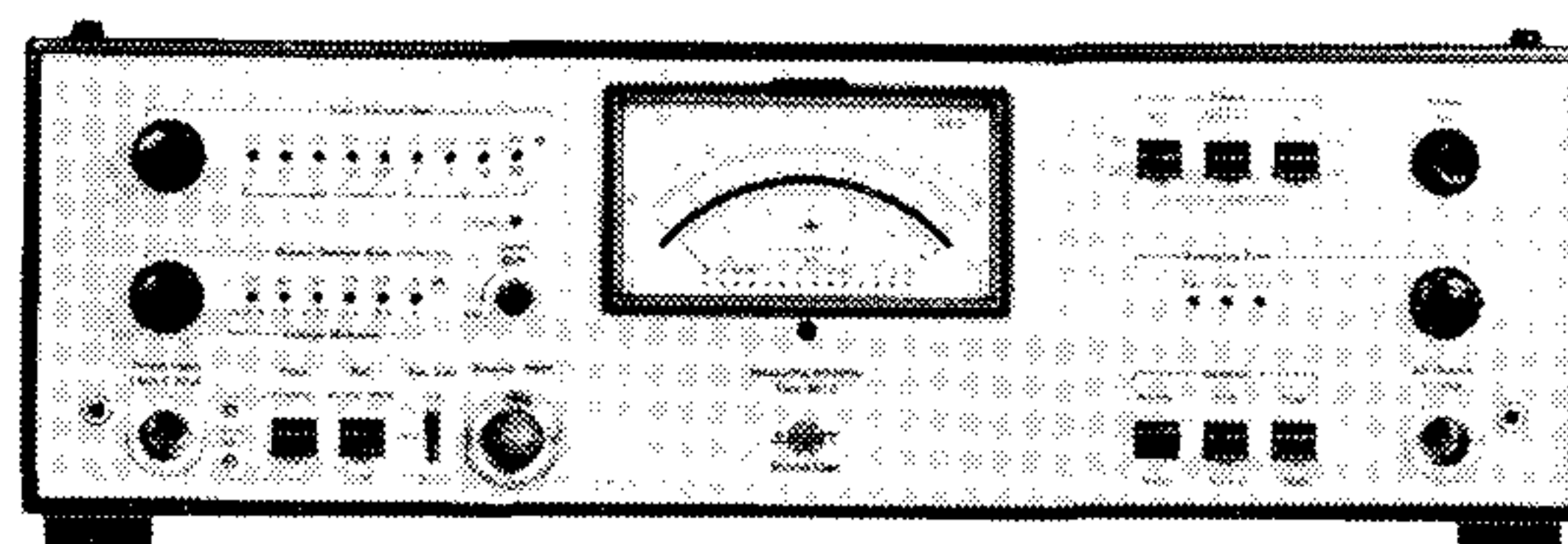

The B & K Measuring Amplifier Type 2610 is an easy to use calibrated amplifier-voltmeter with comprehensive facilities for use in measurement and analysis set-ups for investigation of sound, vibration and voltage signals.

The 2610 has a linear frequency range covering 2 Hz to 200 kHz and a built-in A-weighting filter network so that it can be used as a precision sound level meter conforming with the consolidated revision to IEC R123 and 179 (Type 0), DIN 45633 (part 1) and ANSI S1.4-1971 (Type 1). External filters may be connected to facilitate frequency analysis.

Both true-RMS and peak detectors are included, and to permit the measurement of transient signals a "Max Hold" function can be used

in conjunction with both detectors. A LMS (log. mean square) detector which gives significantly improved crest factor capability and dynamic range is used. Signal averaging is performed according to the internationally standardised "Slow" or "Fast" time-weighting characteristics for sound measurement. For frequency analysis work, particularly at low frequencies and with narrow bandwidths, a "20 s" averaging time may also be chosen.

Either AC (lin) or DC (log) outputs can be chosen to feed magnetic tape and level or X-Y recorders so that a hard copy record of measurements and analyses can be obtained.

Other facilities included in the 2610 are: Interchangeable meter scales for sound, vibration and voltage measurement; Automatic LED indication of gain, measuring range, and overload conditions; Built-in reference signal source for calibration; and Direct and Microphone inputs (with selectable polarisation voltages).

PREVIOUSLY ISSUED NUMBERS OF BRÜEL & KJÆR TECHNICAL REVIEW

(Continued from cover page 2)

- 4-1974 Underwater Impulse Measurements.
A Comparison of ISO and OSHA Noise Dose Measurements.
Sound Radiation from Loudspeaker System with the Symmetry of the Platonic Solids.
- 3-1974 Acoustical Investigation of an Impact Drill.
Measurement of the Dynamic Mass of the Hand-arm System.
- 2-1974 On Signal/Noise Ratio of Tape Recorders.
On the Operating Performance of the Tape Recorder Type 7003 in a Vibrating Environment.
- 1-1974 Measurements of Averaging Times of Level Recorders Types 2305 and 2307.
A simple Equipment for direct Measurement of Reverberation Time using Level Recorder Type 2305.
Influence of Sunbeams striking the Diaphragms of Measuring Microphones.

SPECIAL TECHNICAL LITERATURE

As shown on the back cover page, Brüel & Kjær publish a variety of technical literature which can be obtained from your local B&K representative.

The following literature is presently available:

- Mechanical Vibration and Shock Measurements
(English, German, Russian)
- Acoustic Noise Measurements (English), 3. edition
- Acoustic Noise Measurements (Russian), 2. edition
- Architectural Acoustics
- Strain Measurements
- Frequency Analysis (English)
- Electroacoustic Measurements
(English, German, French, Spanish)
- Catalogs (several languages)
- Product Data Sheets (English, German, French, Russian)

Furthermore, back copies of the Technical Review can be supplied as shown in the list above. Older issues may be obtained provided they are still in stock.

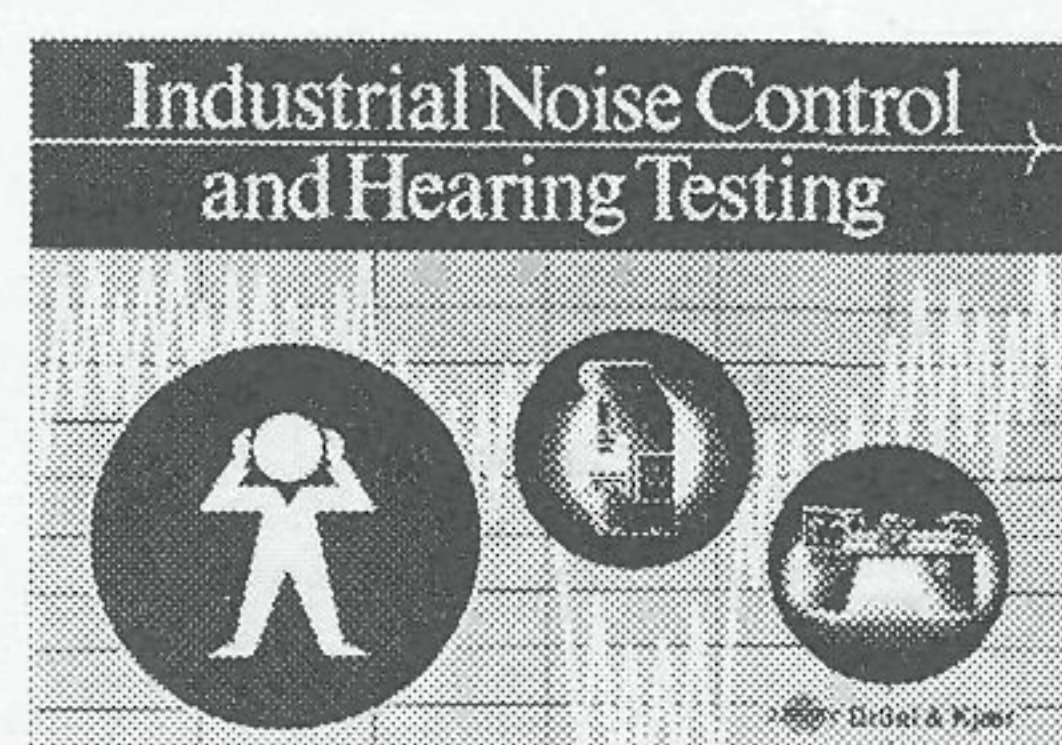
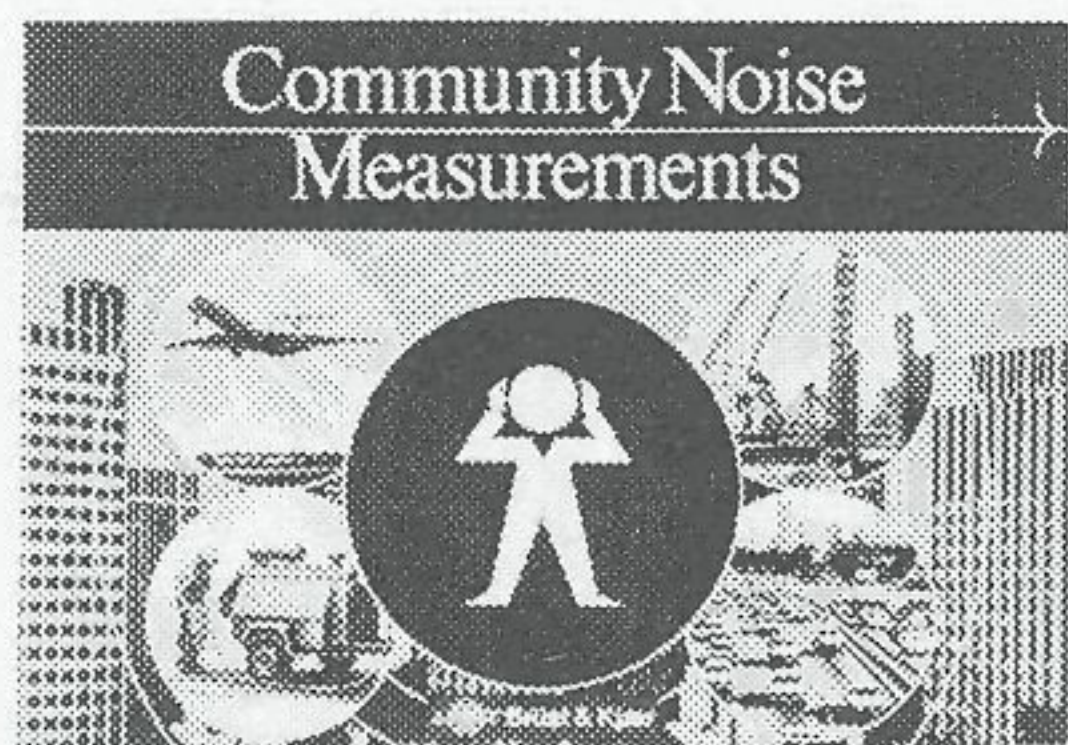
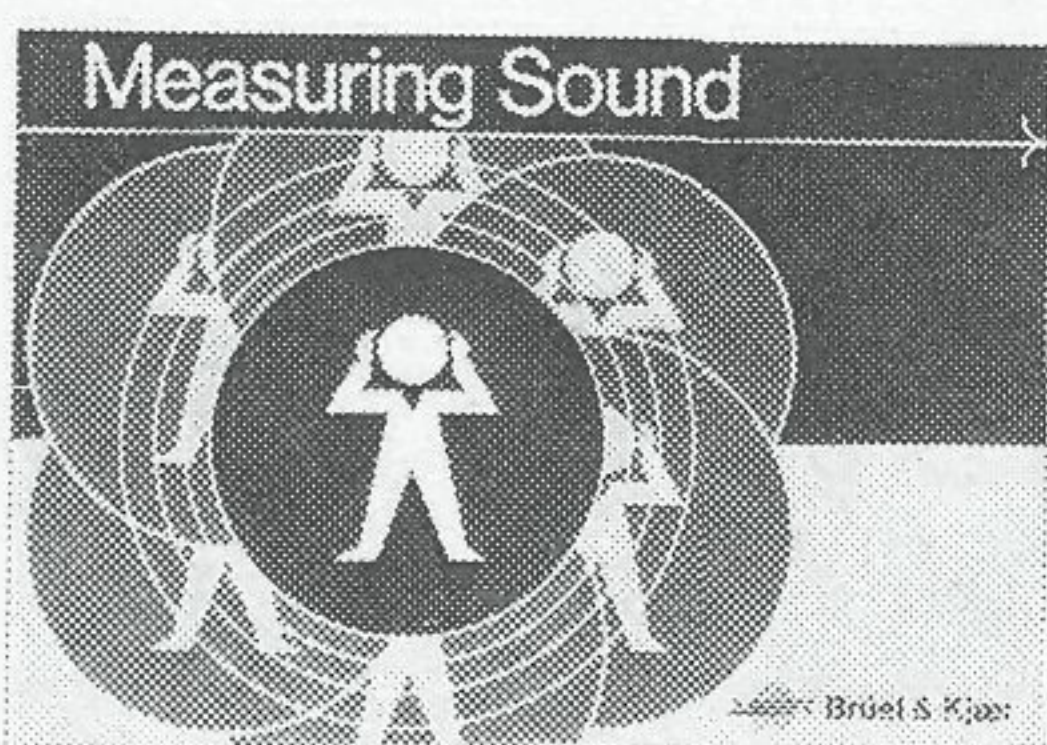
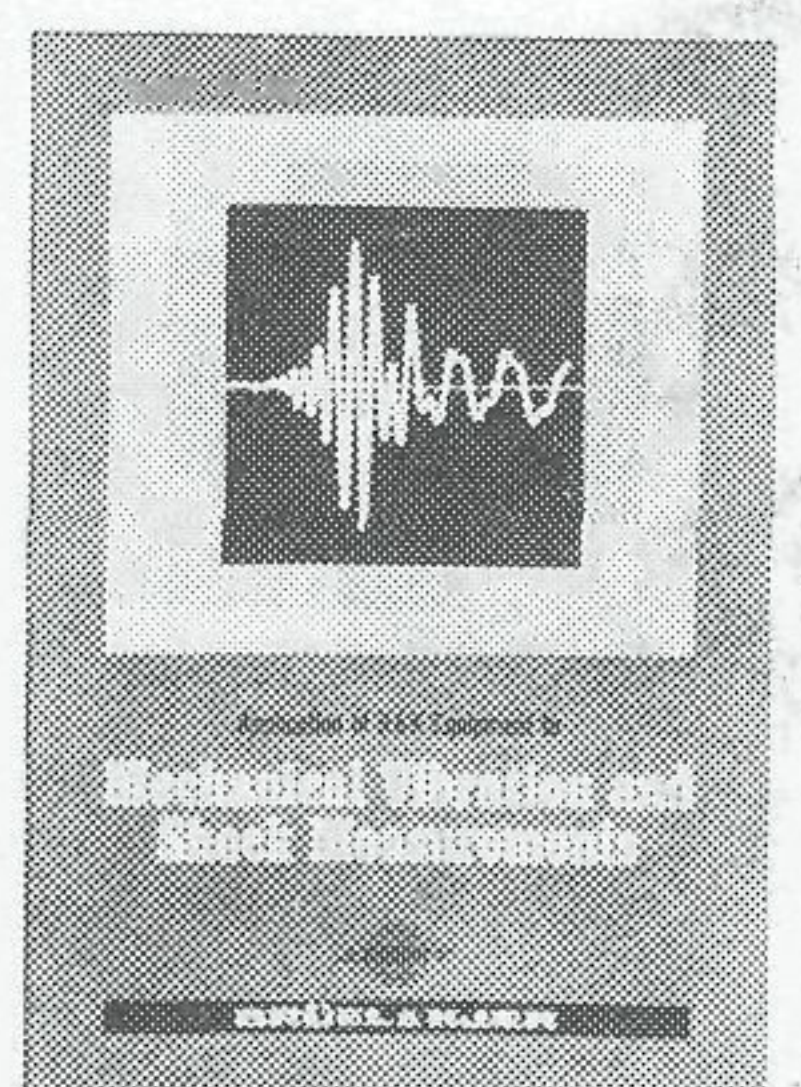
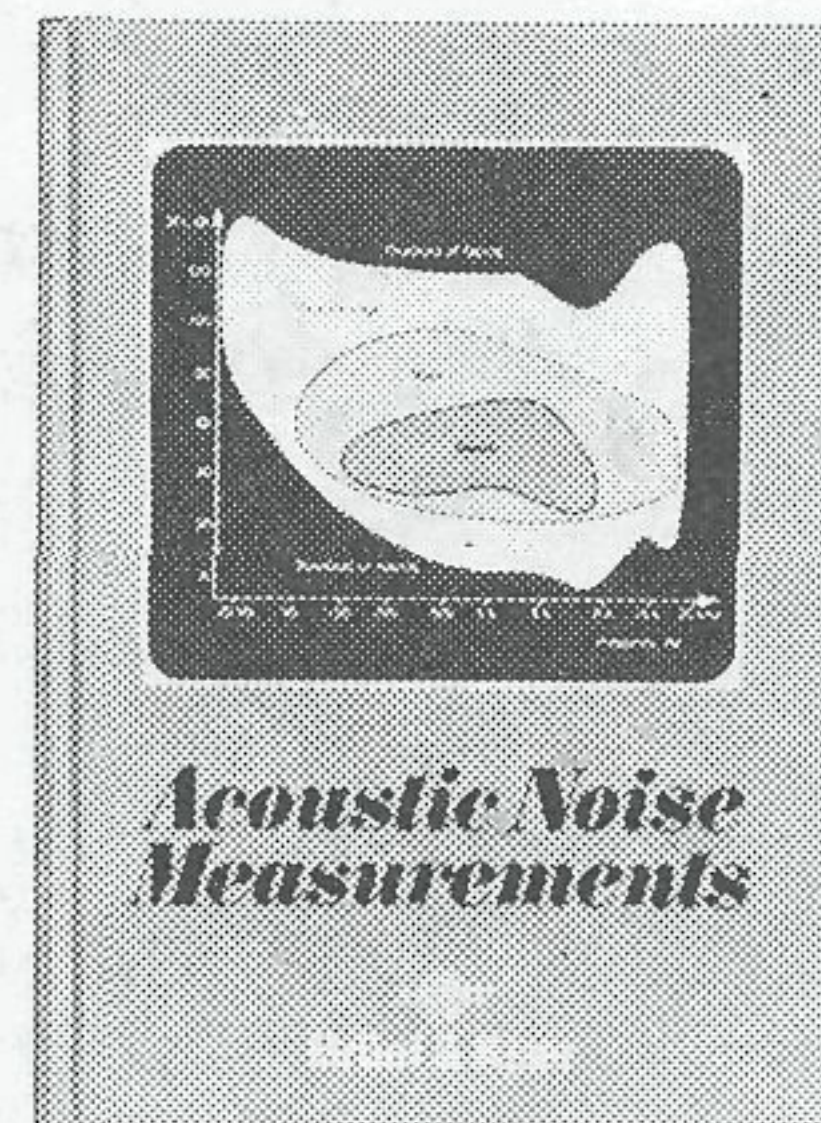
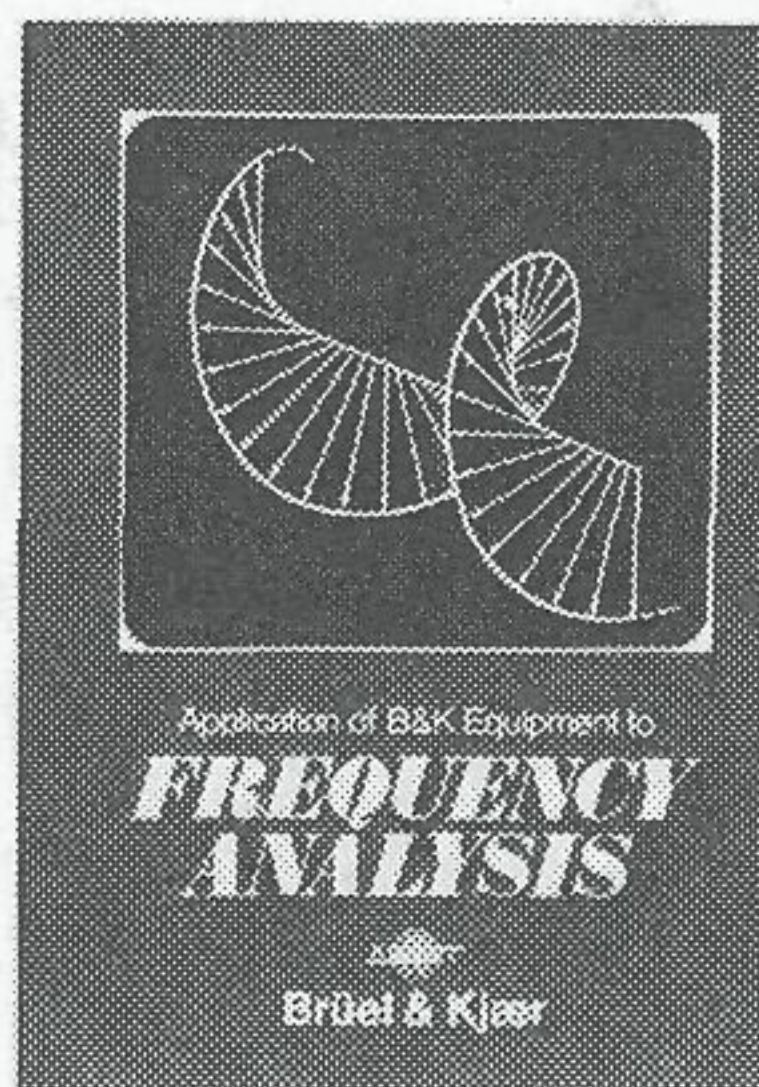
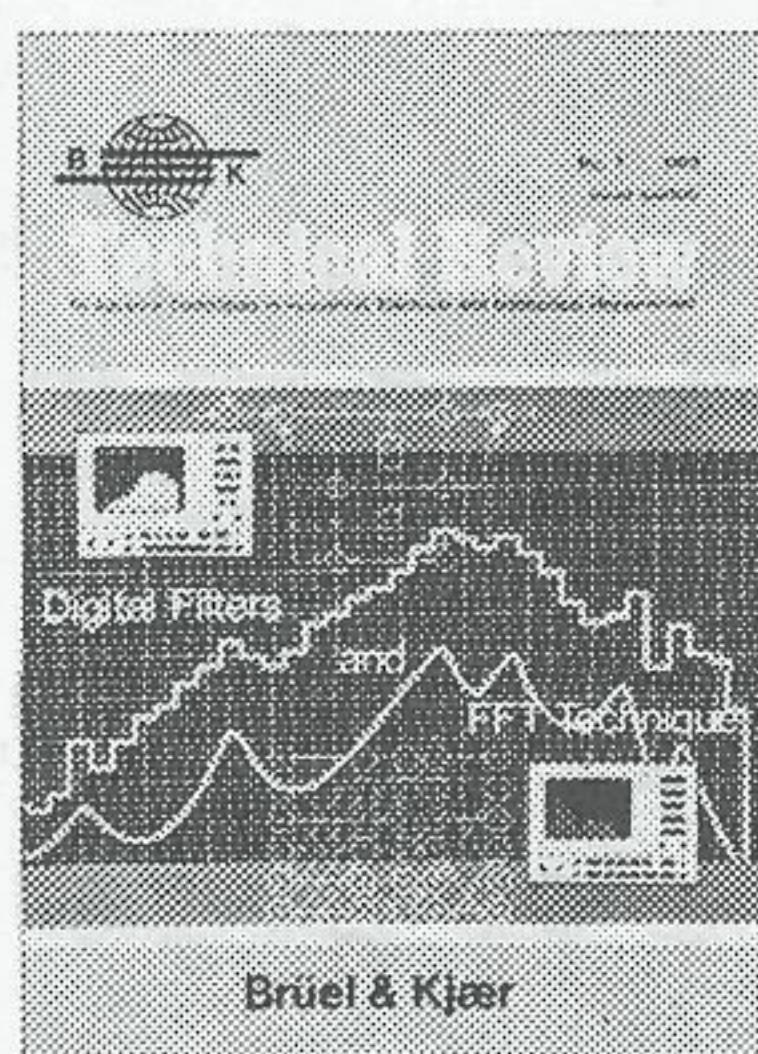
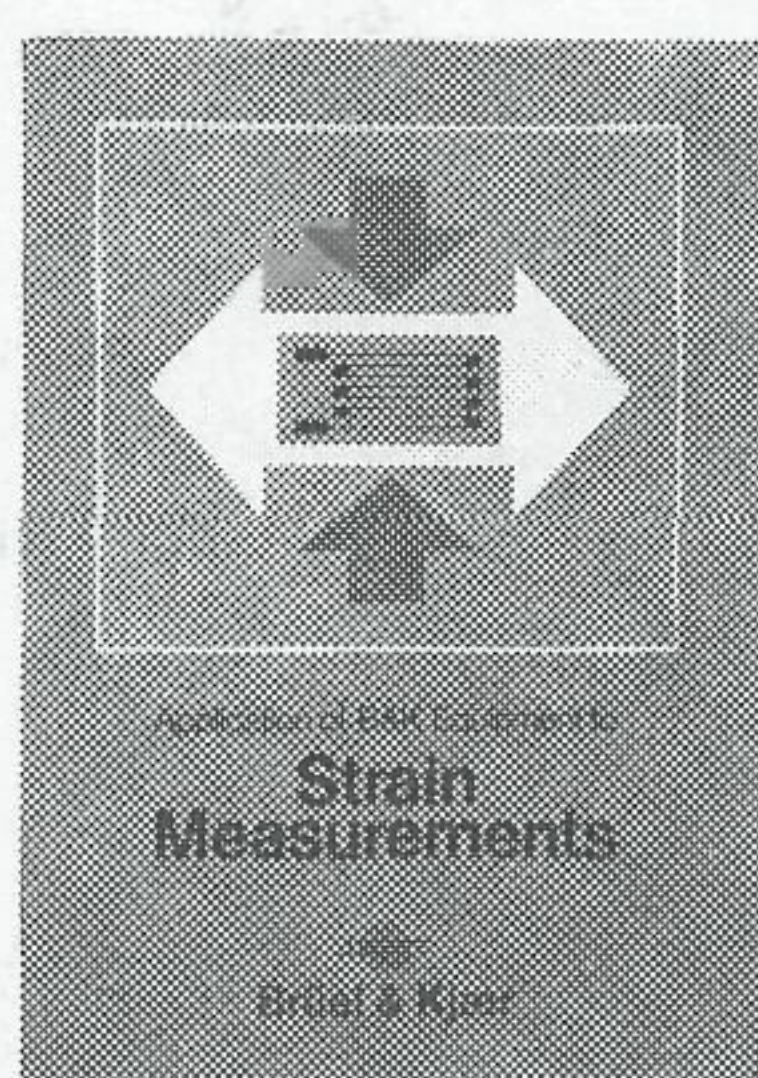
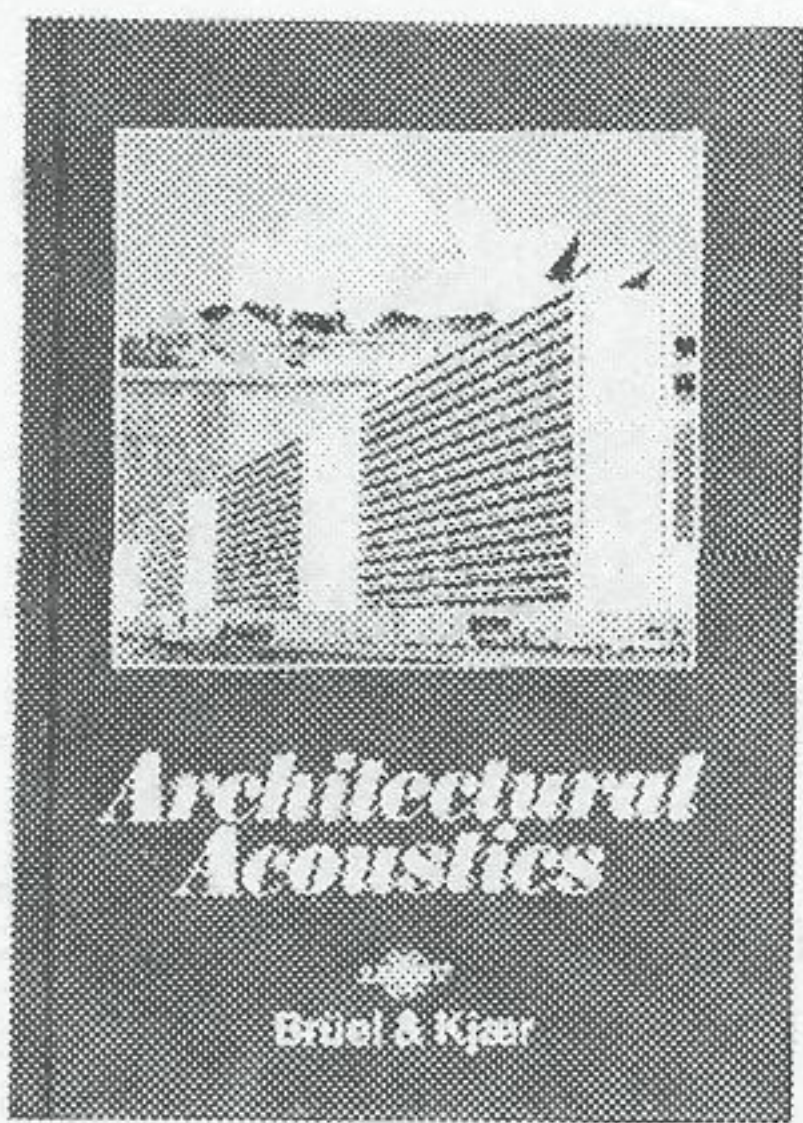
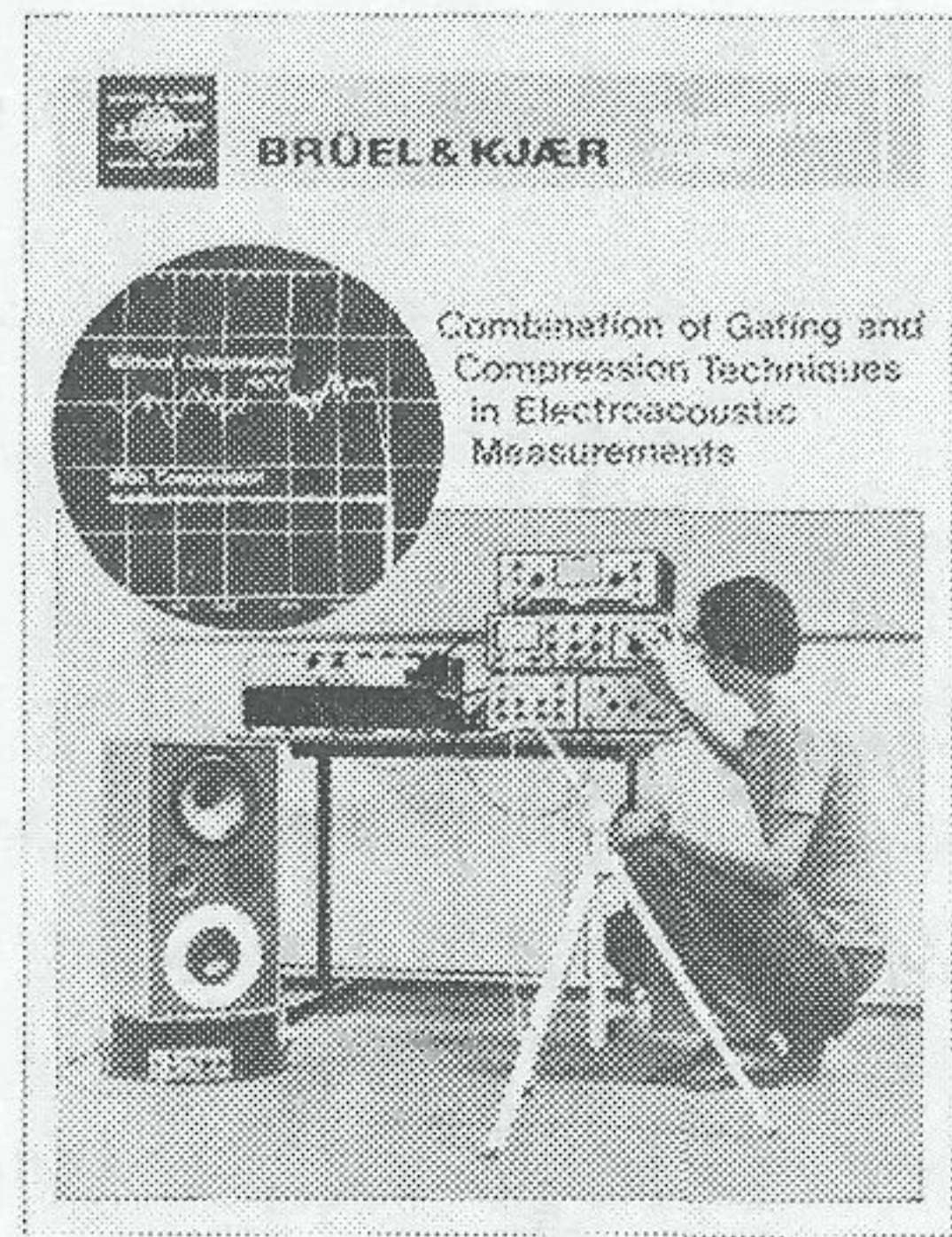
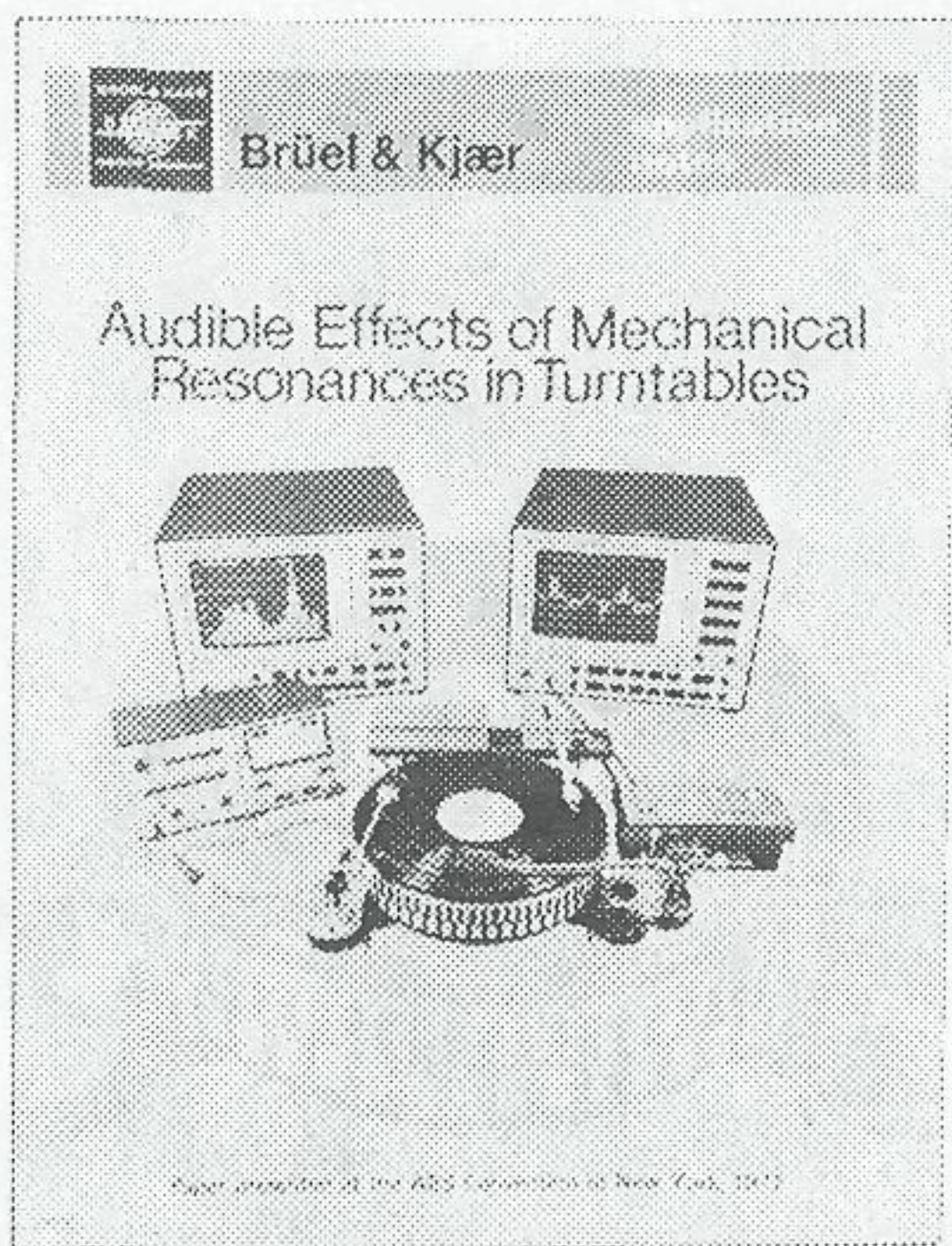
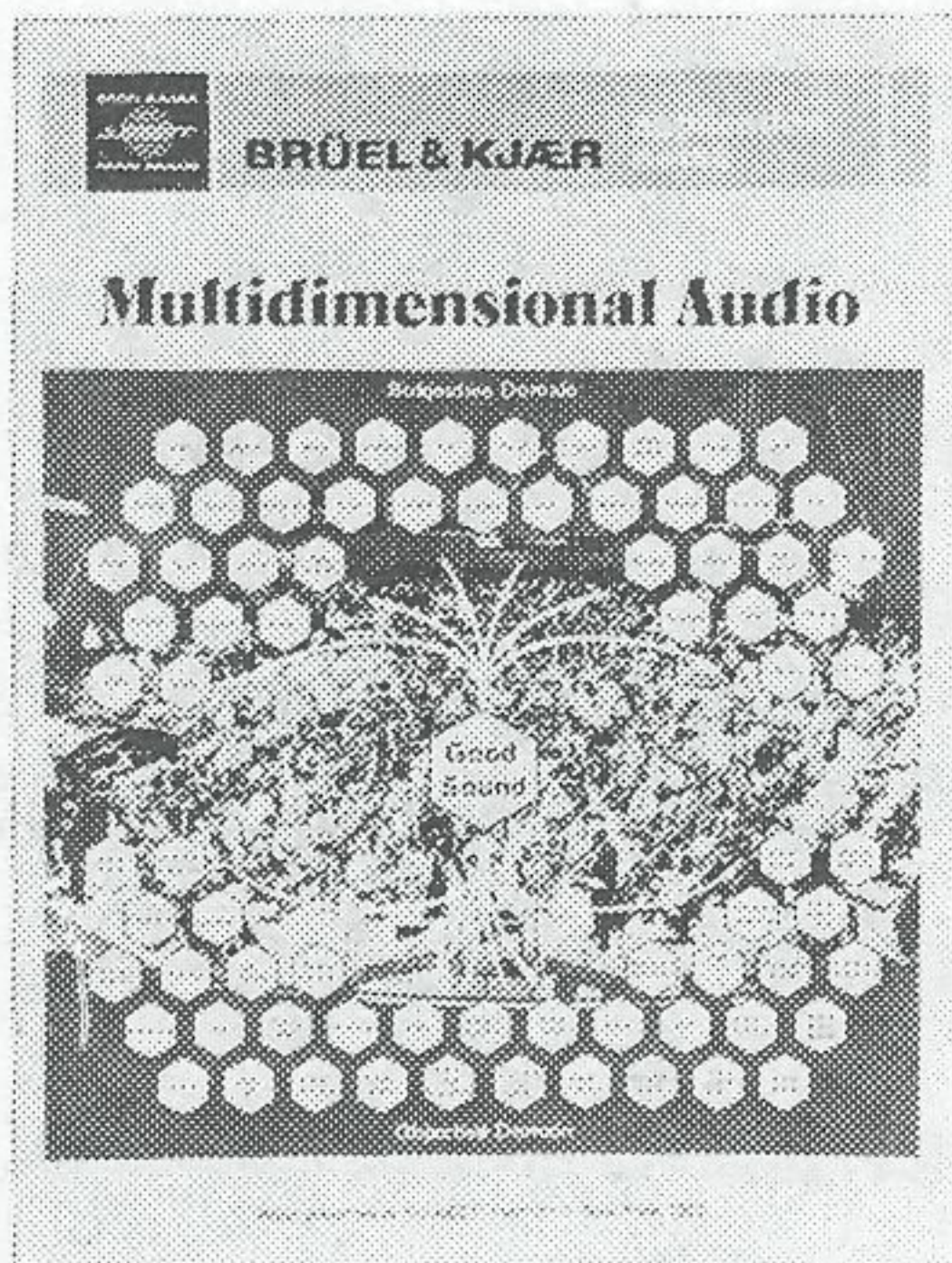
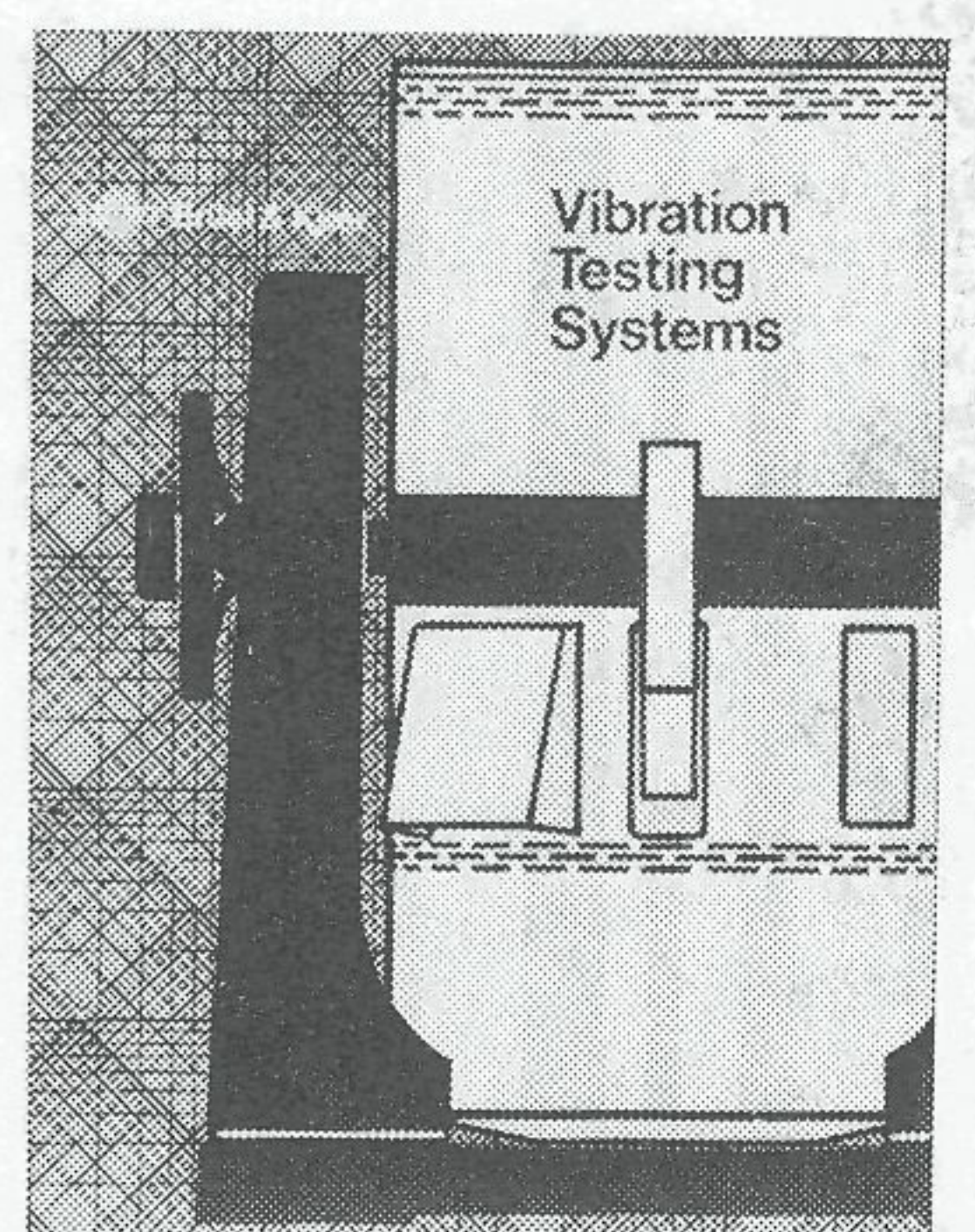
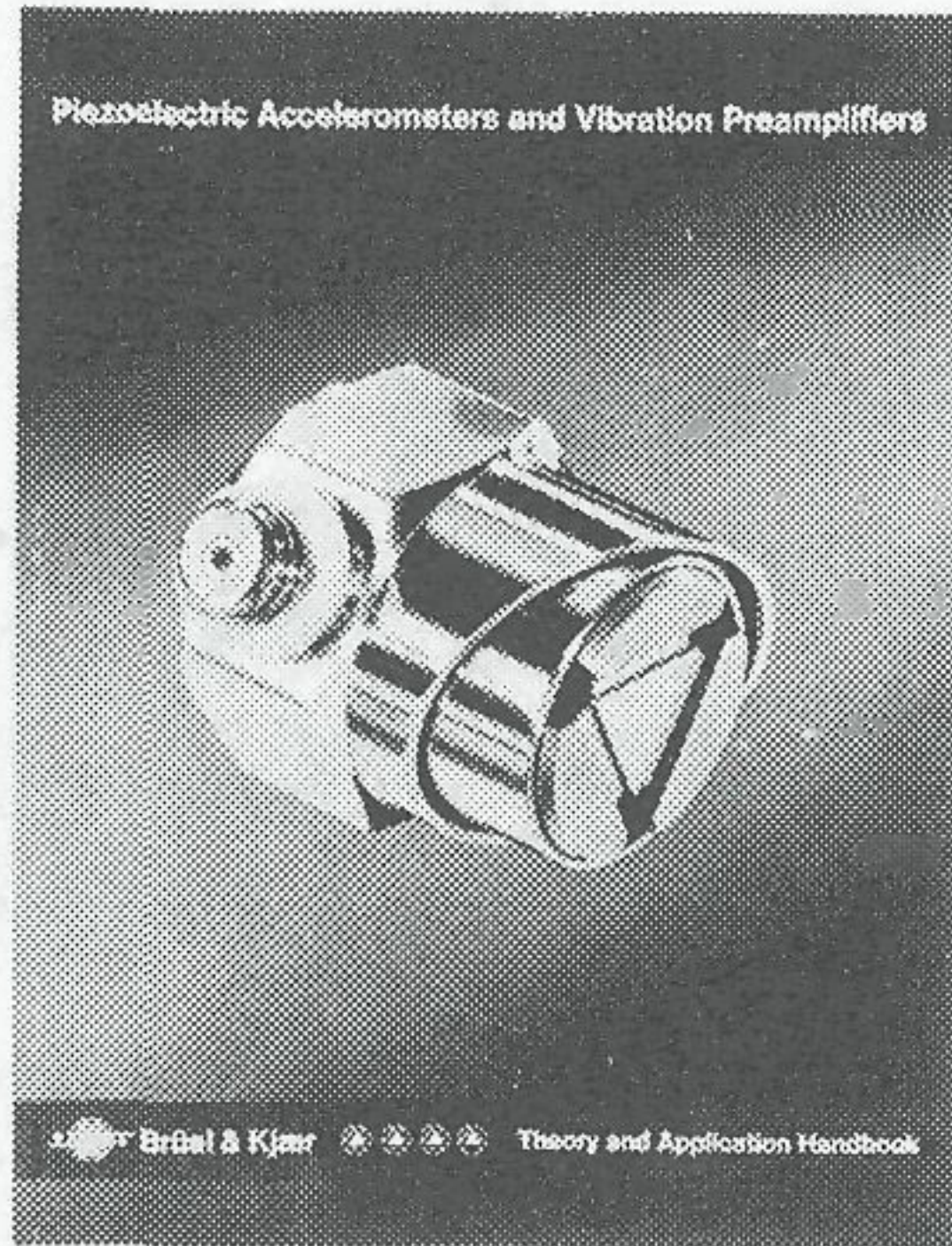
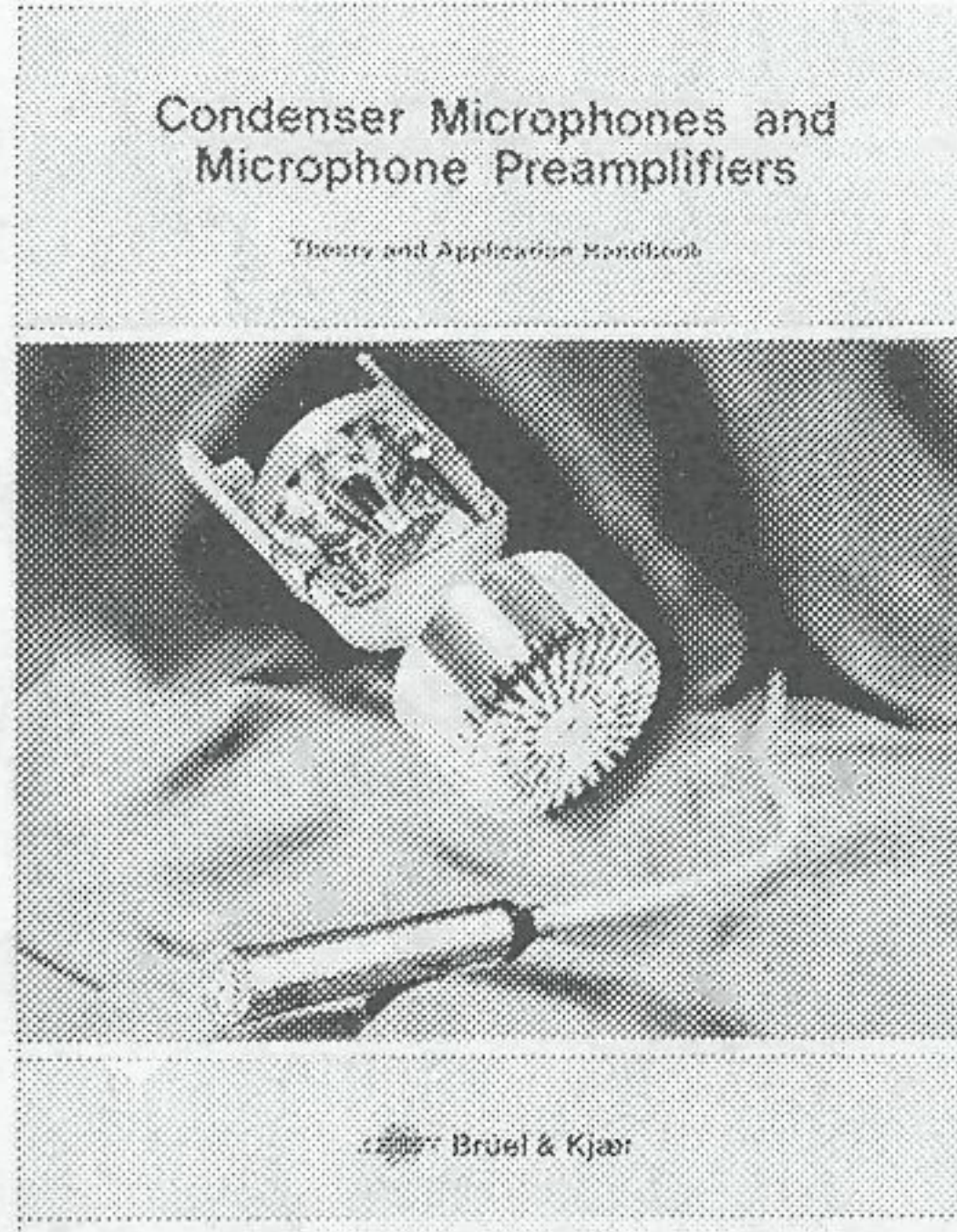
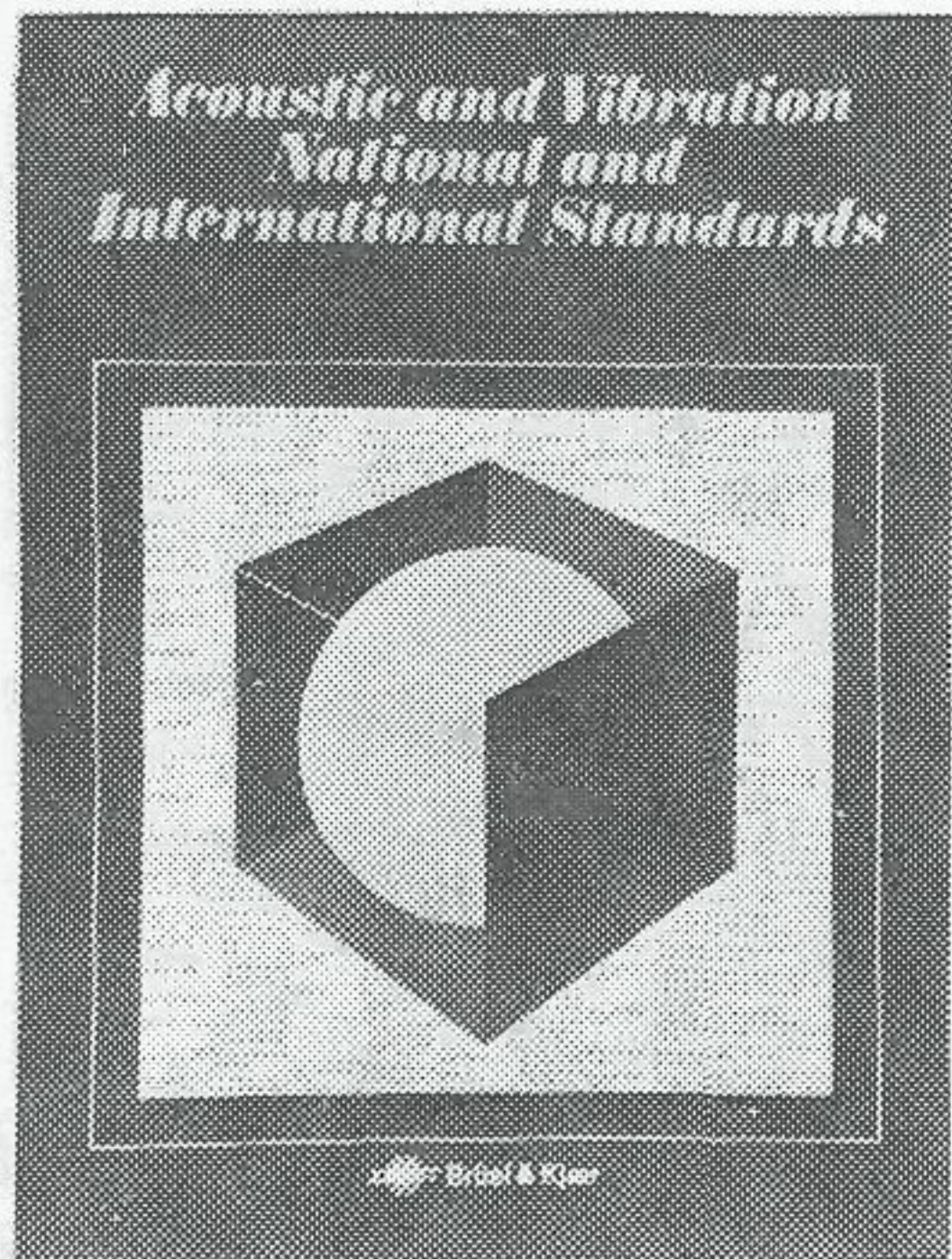

Brüel & Kjær

DK-2850 NÆRUM, DENMARK · Telephone: + 45 2 80 05 00 · Telex: 37316 bruka dk